

OHD



QuantiFit2 MANUAL

Contact Us:



www.OHDGLOBAL.com
techsupport@ohdglobal.com



+1 205.980.0180

Table of Contents

Introduction	2
How the QuantiFit2 Works	4
Instrument Setup	5
Startup Wizard	9
Navigation	11
Performing a Test	16
Reports	18
Daily Verification	19
Onboard Settings	20
OHD Logic	24
Software Updates	26
Home Screen	27
People	31
Company	32
Tests	33
Logic Settings	35
Devices	37
Respirators	38
Reports	40
Troubleshooting	41
Calibration and Maintenance	47
Appendix A: Specifications	48
Appendix B: Import Personnel Template	49
Appendix C: Terminology	50
Appendix D: CNP Diagram	51
Appendix E: Regulations	52
Appendix F: Fit Test Adapters	53

Introduction

© All rights reserved. No parts of this work may be reproduced in any form or by any means - graphic, electronic, or mechanical, including photocopying, recording, taping, or information storage and retrieval systems - without the written permission of the publisher. OHD provides this electronic copy which may be printed only for our customer's use. Products that are referred to in this document may be either trademarks and/or registered trademarks of the respective owners. The publisher and the author make no claim to these trademarks.

While every precaution has been taken in the preparation of this document, the publisher and the author assume no responsibility for errors or omissions, or for damages resulting from the use of information contained in this document or from the use of programs and source code that may accompany it. In no event shall the publisher and the author be liable for any loss of profit or any other commercial damage caused or alleged to have been caused directly or indirectly by this document. For further information, please contact the manufacturer:

OHD, LLLP

2687 John Hawkins Pkwy | Hoover, AL 35244 | U.S.A

+1.205.980.0180 | www.ohdglobal.com

sales@ohdglobal.com | techsupport@ohdglobal.com

Welcome

The QuantiFit2® can be used standalone or with OHD Logic software. When testing without a computer, all reports and test data may be retrieved from the instrument. Data can be imported into Logic software. The instrument is not compatible with FitTrack Gold, which comes with the legacy Quantifit. However, data from FitTrack Gold can be imported into OHD Logic software. The QuantiFit2 comes with an external power supply and can be powered by an optional battery. The QuantiFit2 has an optional removeable/rechargeable battery pack. Only the OHD battery pack Part number FTK 3010-4023 may be used with the QuantiFit2. Go to <http://www.ohdglobal.com> for information on purchasing the battery pack.

Safety and Environmental

The instrument and related documentation must be reviewed for familiarization with safety markings and instructions before operating the instrument. The Quantifit2 is for use at an altitude up to 3,100m (10,170ft.). The operating temperature range is 5 to 40 degrees C, (60 to 104 F) when powered by the external power supply; 5 to 45 degrees C, (60 to 113 F) when powered by the optional battery pack, and 5 to 29 degrees C, (60 to 84 F) when powered by the external power supply with the optional battery pack installed. If the included power supply becomes faulty or damaged, it must be replaced with OHD part number FTK 3010-4021, whose ratings are listed in the [Appendix A: Specifications](#). The QuantiFit2 has an optional removeable/rechargeable battery pack. Only the OHD battery pack part number FTK 3010-4023 may be used with the QuantiFit2. Call OHD (+1.205.980.0180) for information on purchasing replacement power supplies and/or battery packs. The maximum relative humidity is 80% non-condensing and pollution degree 2. If the Quantifit2 is not used specifically in the manner outlined in this manual and for its intended use, the protection of the instrument may become impaired. Under abnormal conditions, such as static discharge, it may be necessary to cycle power to achieve proper operation.

Introduction

Statement on Cross-contamination

The risk of cross contamination resulting from the use of a QuantiFit2 is very minimal. Fit Testing itself **does not** increase or decrease a person's risk of exposure to any virus or illness. The real threat is coming into close contact with an infected person no matter the location or activity.

The QuantiFit2 does not trap air in its system either before, during, or after a fit test. The QuantiFit2 does not push air into the mask. The QuantiFit2 pulls air away from the test subjects' respirator and vents it out of the system. This means that the chances of contaminated air being in the system are, at worst, no more likely than contaminated air being in the surrounding environment. If an infected person were to be fit tested, there is no more risk of contaminated air being trapped and subsequently released on a succeeding fit test than there is just by walking into the fit test area.

The QuantiFit2 and accessories are subject to surface contamination like any item in the test area. Before and after fit test steps, when the test subject is wearing a respirator, his or her inhalation is coming through inlets in the OHD adapter kit, and most of the exhalation should travel through the exhalation valve and out of the respirator. There are many potential respirator and adapter configurations. The chance could exist in a configuration that exhaled breath could contact internal areas of an adapter kit. If it is suspected this has happened, disinfection would be appropriate.

For protection against the transference of surface contamination, all possibly contaminated surfaces the operator or subjects may contact need to be disinfected. This includes the QuantiFit2 and accessories. The adapter kits may be cleaned either by immersion, spray, or wipe from an EPA approved disinfectant as these have been shown to efficiently inactivate over 99% of microorganisms (to include COVID-19) within a minute. The adapter should be dry before use in a fit test. The QuantiFit2 tubing should be carefully wiped down with an EPA approved disinfectant.

If there is a threat of contamination, the fit test operator should take precaution when carrying out fit testing according to the guidance provided by the CDC.

If respirators are shared for fit testing, the fit test operator should follow *OSHA 1910.134 Appendix B-2 Respirator Cleaning Procedures* or the manufacturer's guidelines for the disinfection of the respirator to avoid any cross contamination.

See [Appendix D: CNP Diagram](#) for an air-flow diagram with Controlled Negative Pressure and the QuantiFit2 system.

How the QuantiFit2 Works

The QuantiFit2 functions by creating and maintaining a negative pressure in the respirator. Once the adapter valve is closed, sealing the respirator, the QuantiFit2 removes air from the respirator until the challenge pressure is reached.

When the challenge pressure is reached, if there isn't a leak, the QuantiFit2 doesn't remove any more air from the respirator. If there is a leak, air enters the respirator. The QuantiFit2 then removes air from the respirator until the challenge pressure returns to the targeted value. This process continues for 8 seconds, and then the test step ends.

During the fit test, the QuantiFit2 measures exactly how much air the instrument removed from the respirator after reaching the challenge pressure. This measurement is equivalent to the leak rate.

Challenge pressure, expressed in inches of water, is the maximum partial vacuum created in a correctly fitting respirator when the user is working at a moderate to high rate. The modeled breathing rate is the calculated total inspiration for one minute.

The modeled breathing rate is expressed in liters per minute (LPM), and is multiplied by 1,000 to provide cc/min, it is then divided by the leak rate in cc/min. This is the fit factor ratio. It is a ratio of the total inhalation pressure to the air that leaked into the respirator.

Fit Factor Explanation

The ratio of the modeled breathing rate to the measured leak rate is the calculated fit factor and is expressed by the following equation:

$$\text{Fit Factor} = \frac{\text{Modeled Breathing Rate (cc/min)}}{\text{Measured Leak Rate (cc/min)}}$$

The modeled breathing rate (MBR) is the rate at which an individual could be expected to breathe under moderate to heavy working conditions. The MBR is predetermined for the standard respirator types. The MBR is calculated from the parameters specified by the operator for custom respirators.

The measured leak rate (MLR) is directly related to respirator fit and integrity. All fit factors are calculated from the MLR. The QuantiFit2 directly measures air leakage in cubic centimeters per minute (cc/min) and then calculates the fit factor (FF).

The overall fit factor is calculated by using the harmonic mean of the fit testing steps as follows:

$$\text{Overall Fit Factor} = \frac{N}{[1/FF1 + 1/FF2 + \dots 1/FFN]}$$

Where:

N = The number of exercises;

FF1 = The fit factor for the first exercise;

FF2 = The fit factor for the second exercise;

and *FFN* = The fit factor for the *n*th exercise

Instrument Setup

What comes with the QuantiFit2?

- The QuantiFit2 Respirator Fit Tester
- Triple tube set
- Power supply and power cord
- USB cable
- Hard case with extendable handle and wheels
- Logic software
- Calibration Certificate

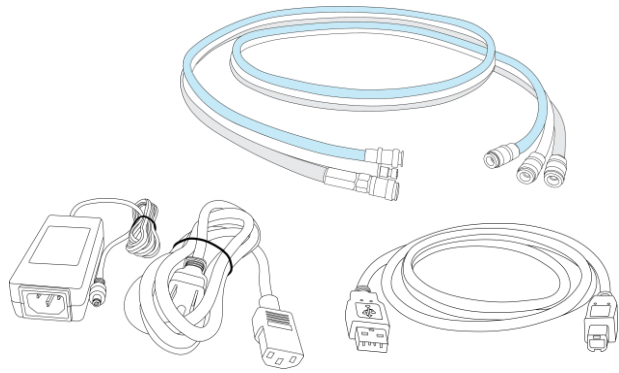

Unpacking the QuantiFit2 Carrying Case:

Release the two latches on the front of the case by depressing the moveable lever under each latch.

- A.** Power cord
- B.** Batteries (optional)
- C.** Adapters (optional)
- D.** Power Supply
- E.** USB Cable
- F.** Tube Assembly
- G.** Additional Storage

Available Accessories

- [Respirator adapters](#) (required for fit testing)
- Rechargeable battery pack
- Printer (standard printer and/or cardprinter)
- USB Keyboard
- Trigger button

Startup

- Connect the power supply or insert battery
- Turn on the instrument with the rocker switch on the rear panel
- Follow the startup wizard (during initial setup only)
- Follow instructions for Daily Verification
- Ready to test

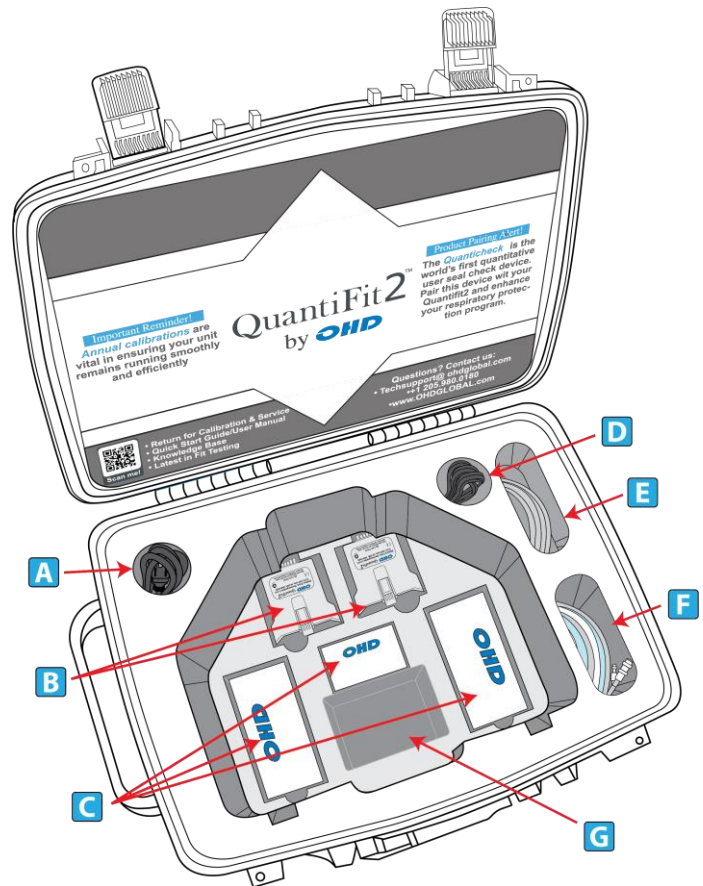

Instrument Setup

Instrument Front Connections

- A. Carrying Handle
- B. Color Touch Screen
- C. Clear Tube Connection
- D. Gray Tube Connection
- E. Blue Tube Connection
- F. Verification Connection for Gray/Clear Tube
- G. Verification Connection for Gray/Clear Tube
- H. Verification Connection for Blue Tube
- I. Daily Verification Connection Points
- J. Instrument Exhaust Port

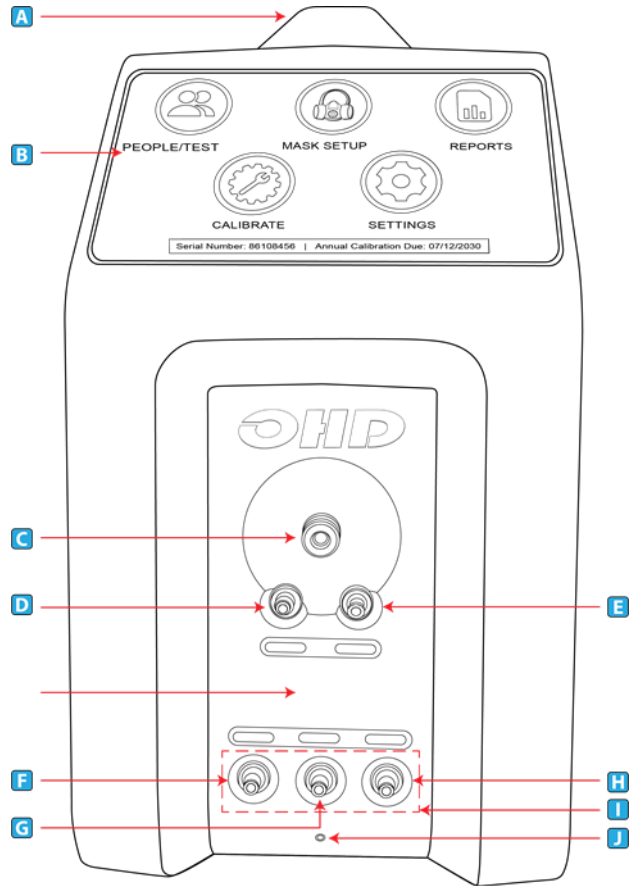

Instrument Setup

Instrument Rear Connections

- A. **On-Off Switch** - The On-Off Switch functions like a standard power switch. Toggle up (|) and the power is turned on. Toggle the switch down (o) and the power is turned off.
- B. **12 VDC, 3A (max) Power Connection** - The power connection is to supply power to the unit, and the universal power supply shipped with the QuantiFit2 must be used.
- C. **Trigger Button Connection** – If the optional Trigger Button is used to initiate test steps, it must be inserted into this port.
- D. **USB Devices (4)** - The four standard USB ports may be used to connect a Keyboard, printer, USB memory stick, or other useful devices.
- E. **USB PC Port** - The USB PC Port is used to connect the QuantiFit2 to a personal computer. The QuantiFit2 is shipped with a supplied cable for this purpose. The USB symbol on the cable must face up to properly insert this cable. This cable allows for the QuantiFit2 to be operated from the supplied software.
- F. **Serial Number** – Located in the center, the serial number is important should you require service or support. All records are kept according to the serial number.
- G. **Battery Latch** – Push down on this latch to release the battery pack and pull outward to remove it.
- H. **Battery Pack (optional) or Cover** – When using an optional battery pack to operate the QuantiFit2, it will be inserted here. When no battery pack is purchased, this cavity will be filled with a blank cover.
- I. **Bluetooth Module** (internal, not shown) - When purchased with the Bluetooth function, the QuantiFit2 can wirelessly connect to a computer with Bluetooth capability.

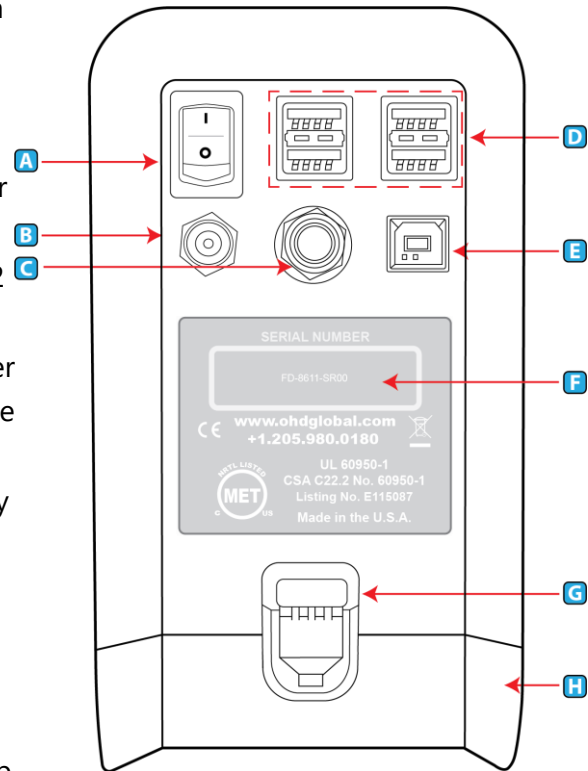

CAUTION: It is vital to open Logic software to pair the device. See [Logic Software](#) section.



OHD Logic software allows users to run multiple machines simultaneously, with flexibility on the start time for any test. Standard Bluetooth allows testing to happen from across the room.

Instrument Setup

Connecting Tubes

It is best to connect the metal quick connects while holding onto the tube and not the connection. The metal quick connect will click into place. The tubing set consists of three tubes (blue, gray, and clear). Out of the six ends of the tube assembly, there is only one male connection, which will always go into the large circle on the front of the unit. The other two tubes should be attached to the color-coded ports. When performing a daily verification, the opposite ends of the tubes should be matched with the corresponding colors on the bottom row of the front panel.

On the Adapter

- The blue tube will always connect to the single port connection.
- The gray and clear tubes will be connected to the port connectors that are side-by-side. The two connections are interchangeable on the adapter and can be placed on either port.

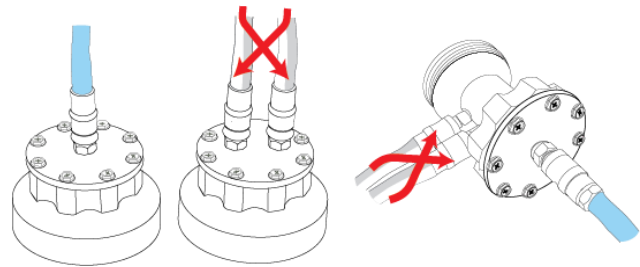

Battery

The optional battery pack can be used in lieu of the power cord. When a battery is in place, if the QuantiFit2 is plugged into a wall outlet and the building loses power, the battery will automatically take over without any interruption to the fit test. The battery may be charged while connected to power whether the QuantiFit2 is in use or not. When fully charged, the battery typically yields approximately four hours of typical testing.

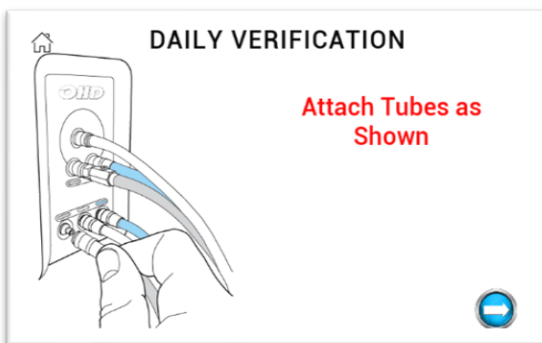
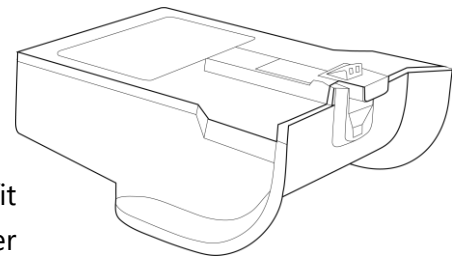

Daily Verification

The daily verification is required for each day of testing. This check measures the leak rate of the leak orifice on the triple tube assembly at various pressure levels and confirms that the diaphragm pump and other processes are working correctly. See the [Daily Verification](#) section for more information.

Startup Wizard

Language

Select your preferred language here.



Regulation

The operator will be required to select the regulation that will be followed for testing in any specific region. This can be changed in the Settings>Admin Menu screen if there is a need to switch regulations. The regulation controls all the test parameters: Select regulation links are listed in [Appendix E: Regulations](#).

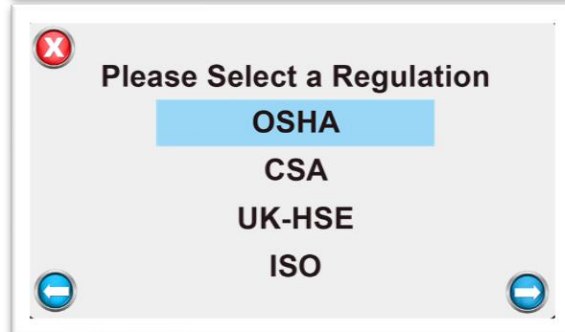

Respirator Selection

Find the respirator(s) that will be used for fit testing and toggle the on/off switch to on. If a particular respirator has not been determined, you may select any respirator and continue. This can be changed later in the Settings>Setup Respirators section.

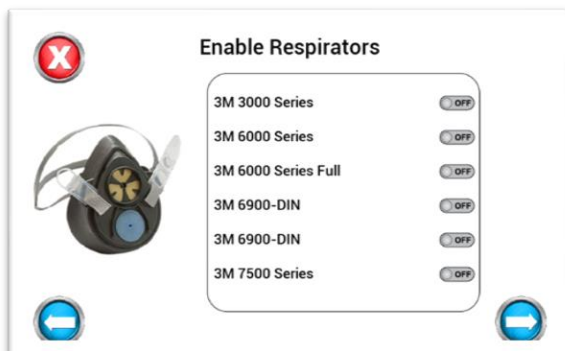

Operators

For every test performed on the QuantiFit2, an operator must be assigned to the record. The Operator screen is used to add/edit operators in the database. Enter one or more operator. Additional operators may be added in the Settings>Admin Menu section. See [Setup Operators](#) for more information.



Startup Wizard

Daily Verification Wizard

This section will guide the operator through a daily verification. This must be performed every day of testing. Upon starting the instrument each day, the Daily Verification screen will appear. See the [Daily Verification](#) of this manual for more information.



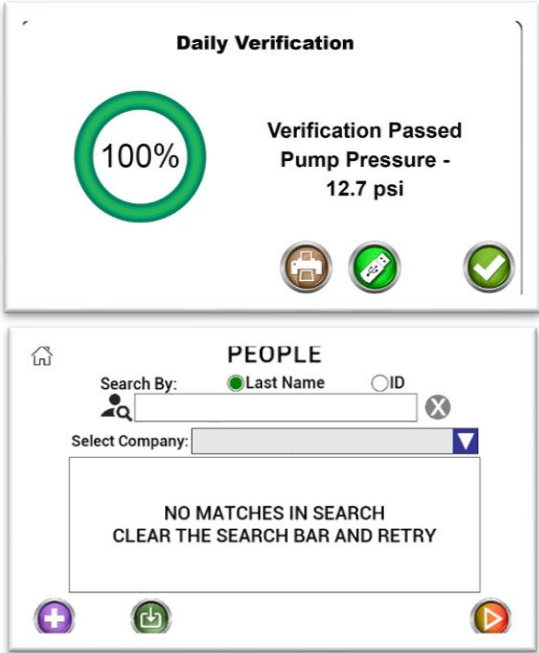

People/Test

After the daily verification check has been performed, the wizard will move on to the People screen. People can be added one by one, imported from a list, or added at the time of a test. The people screen is the last screen in the setup wizard. The operator may close this window or perform fit tests. See [Performing a Test](#) instructions in this manual.









Navigation

The QuantiFit2 is operated by the color touch on the front of the instrument. When pressing any button, there will be a "click-tone". The volume of this tone can be changed in the System Settings menu. There are five major modules to select from:

-  **People/Test:** Where people are added, edited, or imported, and where tests are initiated.
-  **Seal Check:** Holding this button will close off the air flow in the respirator so that the test subject can do a user seal check.
-  **Reports:** Reports that can be printed out or exported one at a time, or by date, company, or group.
-  **Daily Verification:** Used to perform the daily verification requirement for each day of operation.
-  **Settings:** Contains parameters that can be changed for the convenience or requirement of the operator.

Other buttons you will see are:

-  **ADD** – This button will allow the user to add to the records currently viewed, e.g., person, respirator, etc.
-  **ADMIN MENU** - Entry to a menu for secure and important settings
-  **CANCEL** – This button will close the current screen. Any values entered by the operator on the screen will not be saved.
-  **COMPANY** – A separation of people into different groups, teams, companies, etc.
-  **DAILY VERIFICATION** – Will allow the user to perform a daily verification when the initial daily calibration has already been completed
-  **DELETE** – Removes an item from a list

Navigation



DOWNLOAD – For loading people into the QuantiFit2 from the OHD Logic software



EDIT – Allows the operator to change information for the selected item



GO BACK – The back button will allow the operator to return to the previous screen



GO DOWN – To move down through a list



GO FORWARD – This button will guide the operator to the next screen in the sequence



GO UP – This button will guide the operator to move up in a list



NEXT – Takes the operator from the People screen to the test screen



HELP – Dynamic help according to the screen being viewed



HISTORY – Will allow the operator to see recorded information regarding the selected person



HOME - Will bring the operator back to the Home screen



OPERATORS - Add/edit operators that will be testing individuals



PEOPLE/TEST – Add/edit people and initiate fit test

Navigation



PRINT – The print button allows the user to print a report related to the current screen



REPORTS – Brings the operator to a section enabling them to print reports by date or company



RETRY – When a test step is interrupted, this allows the test subject to retry that step



SAVE – The green checkmark will save the information entered on the screen



SEAL CHECK – Allows the test subject to perform a user seal check



SEARCH – A field available on the People screen that allows a search to find the desired test subject quickly and easily



SETTINGS – Enters the screen with options for changing settings on the QuantiFit2



SETUP RESPIRATORS – Add, edit, or delete respirators



SYSTEM INFORMATION – with information including software version, serial number, calibration due date, etc.



UPDATE SOFTWARE – Used when an update is available and saved on a USB drive



USB SAVE – Save report or information to a USB drive plugged into the QuantiFit2

Navigation

People

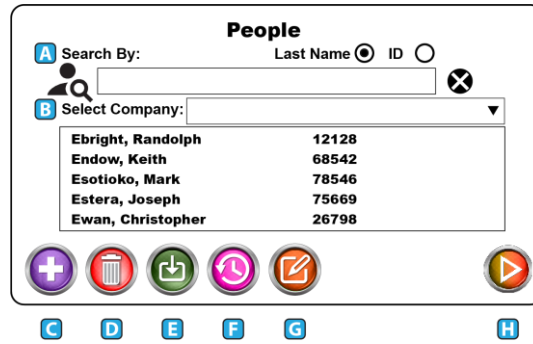

A. Search

Test subjects may be searched by last name or by their personal ID. Click the button to be used for the search. The search will be defaulted to Last Name. Press the X at the end of the search bar to reset all search criteria. Partial names and numbers may be used in the search.

For example:

- Enter an "E" in the search, and all those in the database with the last name starting with "E" will be displayed.
- When specifying a company and typing in an E, only those names starting with E and within the company selection will be shown.

B. Select Company

Company is intended to create a division among the test subjects who are entered into the onboard database. To add a company to the QuantiFit2 database, type in a company name when adding a test subject to the database. The company will be saved automatically along with the test record.

CAUTION: When entering the name of a company, it is critical that it exactly matches the previous entries, or a new company will be created.



C. Add

The Add button will open a screen that will require test subject information. The fields available are Name, ID, Company, Group, and Notes.

D. Delete

When a test subject is selected, press on this icon to delete this person from the instrument. There will be a prompt asking if you are sure that you

The 'Add Person' form contains the following fields:

- Name: First, MI, Last
- ID:
- Company:
- Note:

Navigation icons: X (cancel), checkmark (confirm)

Navigation

want to delete this person from the database.

CAUTION: After deletion, a test subject cannot be restored.



E. Download

The download feature allows test subjects to be uploaded in bulk. This can be done through a CSV file from the OHD Logic software. See [Appendix B: Import Personnel Template](#) for import requirements.

F. History

When a test subject is selected and the history button is pressed, a screen will show any existing tests for this person. Tests will be listed by date.

G. Edit

When selecting a test subject and pressing on the edit button, there will be an opportunity to change the saved information for this person. This includes Name, ID, Company, and Notes.

H. Next

When a test subject is selected, the Next button will move to the test screen

Performing a Test

Test Screen

The test screen prompts the operator or test subject to select or fill in the details of the test. This includes Respirator, Size, and Operator. The Respirator selection will only show the respirators that have been selected during the setup wizard or in the [Setup Respirators](#) module on the settings screen.

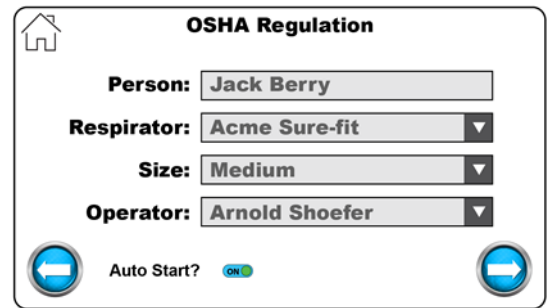

Auto Start

The Auto Start feature is turned on by default. With this on, the test subject takes a comfortable breath preparing to hold it once the circle in the lower right corner fills with green. The QuantiFit2 senses the breath hold and the test automatically begins.

Operator Signature

After the details of the test have been confirmed, the operator can progress to input their signature on screen, if desired. This feature can be turned off in Settings>System Settings>Signature Capture.

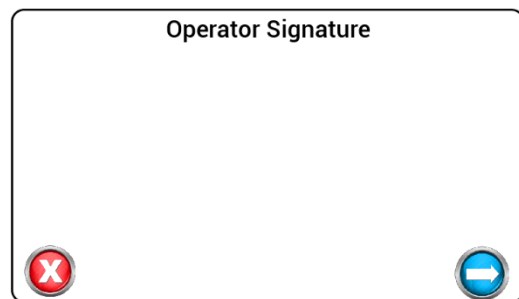

Preparing the Respirator

If the respirator has an inhalation valve at the place where a fit test adapter will be connected to the respirator, it must be removed or propped open.

When the test subject is ready, connect the tube assembly to the adapter(s).

- The blue tube goes to the single port.
- The gray and clear tubes go to the two ports that are located side by side. It does not matter which tube is connected to which of these two connectors. See [Appendix F: Fit Test Adapters](#) for more information.

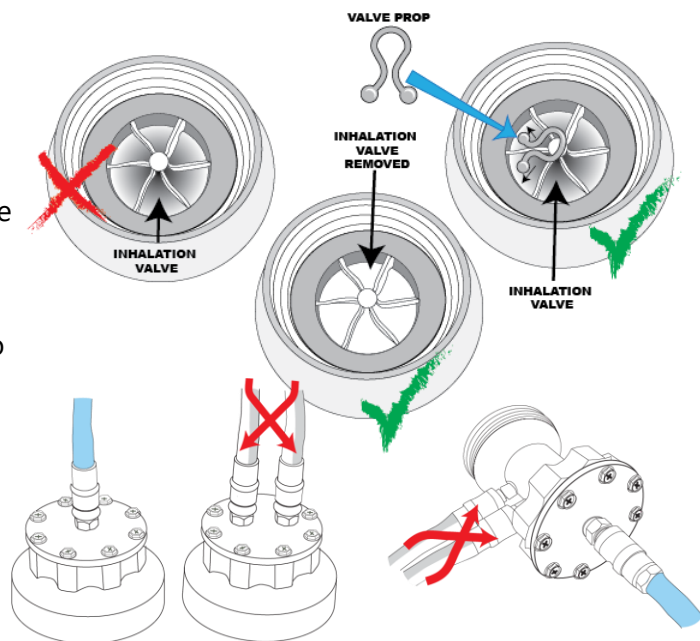

Beginning a Fit Test

After selecting or adding a person to the database, the test can begin. Explain the test to the test subject: During each step, the test subject will be given instructions to be in a specific position for the test, and a possible action to perform before the test step begins.

Performing a Test

Initiating the test step:

With Auto Start

- If the Auto Start feature is turned on: Instruct the test subject to take a comfortable breath preparing to hold it once the circle in the lower right corner fills with green.
 - The test will begin automatically.
 - Remain still for the duration of the test
 - Pressing the green button will also initiate the test.

Without Auto Start

- If not using Auto Start, instruct the test subject to take a comfortable breath preparing to hold it once the circle in the lower right corner fills with green, and then press the green button on the screen.

At the end of each step, a fit factor will show for several seconds. If the fit factor is greater than the minimum fit factor required, the instrument will advance to the next step. If the test should fail for reasons other than a poor fit (test subject coughs, the test starts when the test subject was not ready, etc.), the step may be retried.

After the final step, if the signature feature is enabled, the test subject will sign on the touchscreen.



At the end of the test, the results are saved into the database and cannot be edited. The operator may choose to print the test results immediately or wait to print later. The test is stored and able to be accessed at any time.

Reports



Reports may be printed at the time of the test, or any time after the testing has been completed. The following reports are available on the QuantiFit2:

Fit Test Reports

- Individual

A single-page report that contains all required data for a respirator fit test record. This report includes a fit test card at the bottom of the sheet for the test subject to keep.

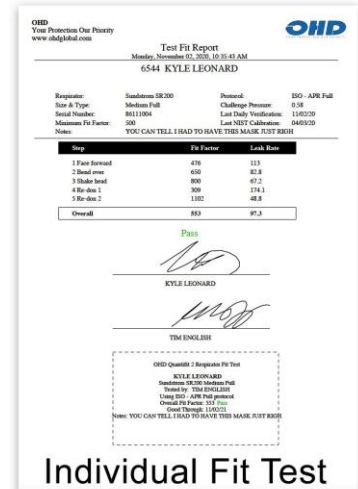

Individual Fit Test

Fit Test Reports

Company:

Person:

Date Range: to

<u>Report Type</u>	<u>Format</u>	<u>Output</u>
<input type="radio"/> Individual	<input type="radio"/> PDF	<input type="radio"/> USB
<input type="radio"/> Summary	<input type="radio"/> CSV	<input type="radio"/> Print
<input type="radio"/> Both	<input type="radio"/> Both	<input type="radio"/> Print

- Summary

A report that will print the specified group of people in a truncated fashion, which allows for many people to be recorded on the same sheet.

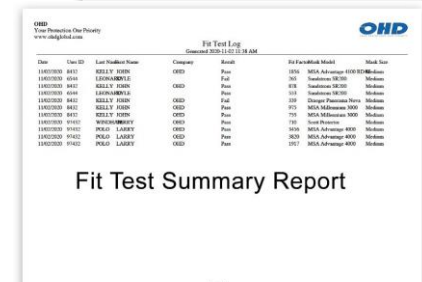

Fit Test Summary Report

Fit test reports can be selected by:

- Company
- An individual person
- Tests that fall within a specific date range



Verification Report

Verification Reports

Quick selections include:

- Today
- Current week
- Previous week
- Current month
- Previous month
- Custom [Date Range]

Verification Reports

Date Range: to

<input type="radio"/> Today	<input type="radio"/> PDF	<input type="radio"/> USB
<input type="radio"/> Current Week	<input type="radio"/> CSV	<input type="radio"/> Print
<input type="radio"/> Last Week	<input type="radio"/> Both	
<input type="radio"/> Current Month		
<input type="radio"/> Last Month		
<input type="radio"/> Custom		

Print/Export Reports

The reports can be saved as a PDF file, CSV file, or both, or printed directly to an approved printer.

Daily Verification



The daily verification is required for each day of testing.

When turning on the instrument for the first time each day, the Operator will first be prompted with the daily verification message. Once the daily verification has been performed for the day, this message will no longer appear when the unit cycles power.

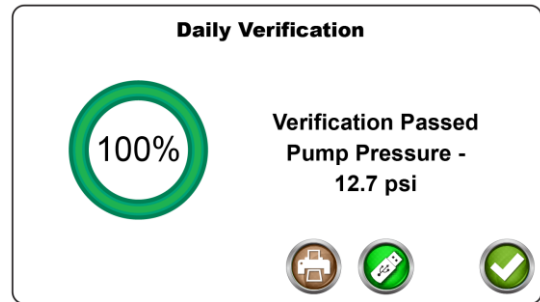

The daily verification measures the leak rate of the leak orifice on the triple tube assembly at various pressure levels and flow rates and confirms that the diaphragm pump and other processes are working correctly.

The daily verification may be performed at other times for other purposes. A Daily Verification button can be found on the QuantiFit2 Home Screen.

Run a daily verification when:

- The instrument moves to another location, especially with any environmental changes.
- Whenever the triple tube assembly is changed.

Troubleshooting:

If the instrument does not pass the daily verification, troubleshooting information will be displayed. If the verification will not pass after troubleshooting steps, the unit may require service. Contact OHD technical support (techsupport@ohdglobal.com).

Onboard Settings



System settings

Cylinder Test Mode is used for demonstration purposed or validation testing.

Volume allows the operator to increase or decrease the volume of the audio indicators that one might hear when testing or entering test data. The settings are 0 to 10, where 10 is the loudest.

Brightness allows the operator to increase or decrease the brightness of the display. The settings are 1 to 10, where 10 is the brightest.

Auto Print is turned on when the operator desires the test automatically to be printed upon completion of a fit test.

Number of Prints allows the operator to select the number of prints when printing reports. To be used when more than one copy is required.

Auto Advance will automatically advance to the next step after a step has passed successfully. If the test step fails, the operator will be given the option to retry the step or advance to the next step. The auto advance feature may be turned off, and the operator must then select the arrow button for the next step, or the retry button when a retry is necessary.

Auto Advance Time allows the operator to set the time given before the test step advances to the next step when the auto advance function is turned on.

Redon Delay is the number of seconds to delay the QuantiFit2 while the test subject redonsthe respirator so that auto start is not analyzing samples while the redon is taking place.

Signature Capture allows the operator to turn off the signature capture at the end of each test if the signatures are not necessary or required.

System Information

The information button will display helpful information when contacting OHD for support including:

- **System Version** – The current version of on-board software
- **Cycle Count** – The number of cycles the instrument has run
- **Calibration Due Date** – The date due for annual calibration requirements
- **Current Date** – Can be changed by touching the current value

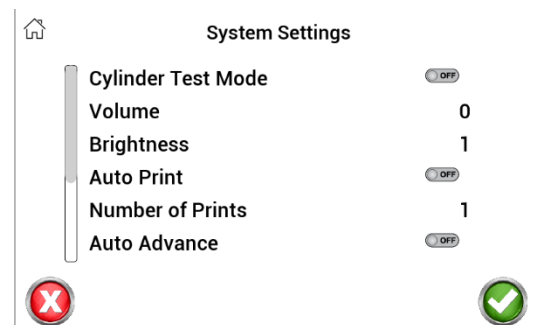
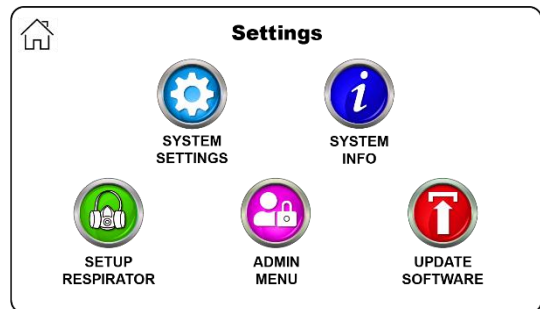

Onboard Settings

- **Current Time** – Can be changed by touching the current value



Setup Respirators

The QuantiFit2 is populated with an extensive list of respirators. When selecting respirators, only those turned "on" will be available as a selection on the Test Information screen during a fit test.

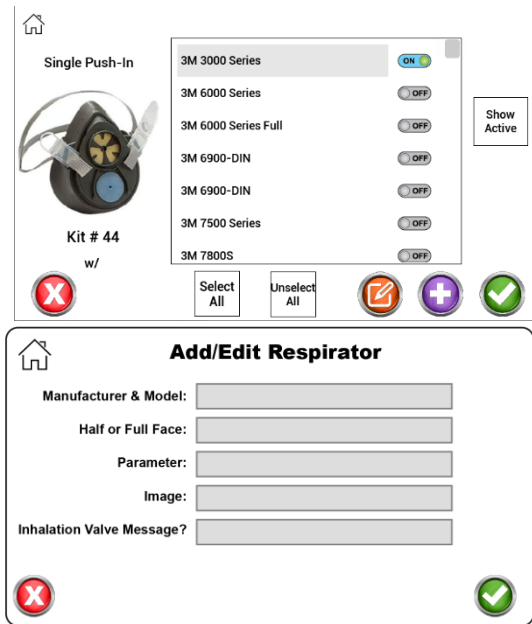

If the respirator that is being tested does not appear on this list, a new respirator may be added to the list. The following fields will be required:

- Respirator Manufacturer and Model
- Half or full face
- Parameter
- Image
 - An image can be uploaded into the database from a thumb drive.
 - The respirator image should be no larger than 240 pixels wide by 370 pixels tall.
 - The respirator image should be a *.png file.
 When no image is uploaded, "No Image Available" will be shown in place of the image.
- Inhalation Valve Message:
 - Turn off the message about the inhalation valve if this respirator does not have an inhalation valve that interferes with the test.



Admin Menu

The Admin Menu is a directory for critical settings. These settings should be changed only by a person who has been trained and understands the purpose of each setting.

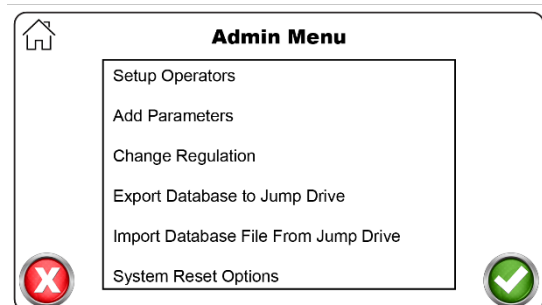

Setup Operators

Operator setup is necessary to record those people who will be running the tests. To record an Operator, there are key fields required:

- First and Last Name
- Email

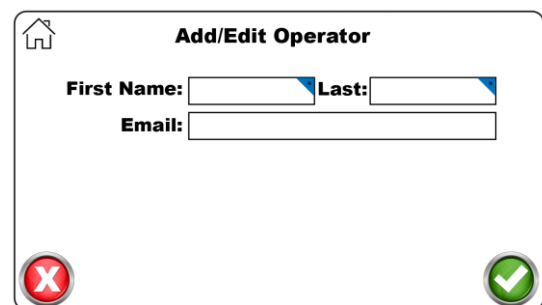

Onboard Settings

Add Parameter

The Add Parameter function will allow an operator to customize options for a particular respirator if the desire is to test outside of the standard testing parameters. You will need to enter:

- Parameter name
- Challenge Pressure: The negative pressure rate at which a respirator is tested
 - 0.58 in H₂O is used in the APR parameters
 - 1.0 in H₂O is used for CBRN and military function
 - 1.5 in H₂O is used for SCBA respirators
- Modeled Breathing Rate: The breath that is emulated during the fit test
 - 53.8 L/min is used for APR settings
 - 55.8 L/min is used for CBRN and military function
 - 93.1 L/min is used for SCBA respirators
- Passing fit factor: The minimum fit factor required to pass a test step and overall fit factor.

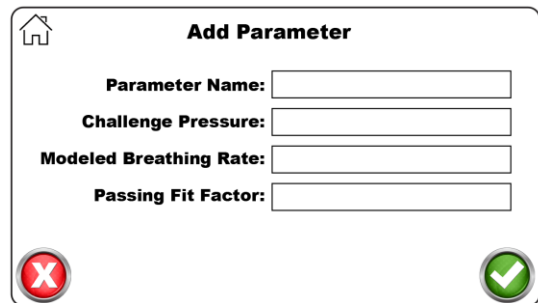

Change Regulation

The QuantiFit2 is designed so that when a regulation is selected, all tests are automatically executed with the correct settings. New regulations will be added in future updates as they become available or are modified. Links to select regulations are listed in [Appendix E: Regulations](#).

Export Database to USB Drive

Allows users to create and save a complete backup of the onboard database including people, fit tests, operators, selected respirators, and various other settings.

Import Database File From USB Drive

This is how you restore a backup database and can also be used to share databases across multiple units.

System Reset Options

There are numerous reset options according to which information needs to be reset:

- Clear People List will remove all the people in the current database.
- Clear Test Records will keep the people list but will delete all test information.
- Clear Operators will remove all operators listed in the unit.
- Clear Custom Parameters will remove any parameters that have been manually added to the database.
- Restore System Defaults will change all operational settings to the settings that were

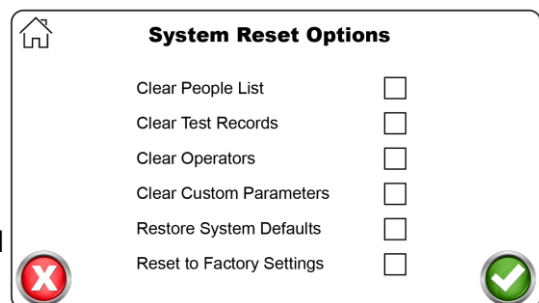

Onboard Settings

originally implemented on the instrument. This option will not erase any of the information listed above.

- Reset to Factory Settings will remove all data on the Quantifit2 and it will operate as though it is the very first time the unit is powered up.

Company Info for Reports is a customizable header that will appear on reports printed directly from the QuantiFit2

Run Battery Drain Procedure

CAUTION: Must be performed to prepare battery for shipping. Please remember this as you prepare to ship your instrument back for annual calibration.



Language Change selected language



Update Software

Occasionally there will be updates to the on-board software. OHD will notify customers when an update is available if the unit has been registered. The notification will come via email. The update can be downloaded from a website and saved to a USB Drive. With the USB Drive in any port on the back of the instrument, the Update Software button will ask the operator to select the update file. After the update, the instrument will automatically cycle power at the appropriate time, reboot the system, and be ready for testing.

Logic

OHD Logic Software is intended to be driven by icons, and each icon function can be viewed by mousing-over the icon. In the case of the icons on the left sidebar, the Menu icon at top left can be clicked, and the menu will pop-out to display the names next to each icon.

As with most programs, there are many ways to do the same task, and different operators may feel more comfortable doing things one way as opposed to other ways. These instructions will cover the different ways to do each item or task.

If there are uncertainties about any part of the software, check the corresponding section in this manual or in the software.

Our goal is to make this software as intuitive as possible. We always welcome feedback.

OHD Logic

OHD Logic Software is to be installed on a PC running Windows software version 10 or greater.
PC requirements:

- Processor Speed: 1.0 GHz or greater
- RAM: 1 GB or greater
- Disc Space: 16 GB

The installation must be completed by someone logged onto the PC who has administrative privileges.

The installation file will install all prerequisite files including Windows requirements.

1. You may have to approve the installation of this file as it might be one that Windows doesn't recognize, or if you downloaded it from our website.
2. You may be prompted to install .Net Core Runtime 3.1.1 This file is required to run Logic. Click Yes to continue the installation, which will take you to the Microsoft dotnet website. Click on the x64 version and follow the install prompts.
3. Follow the install wizard and launch the program

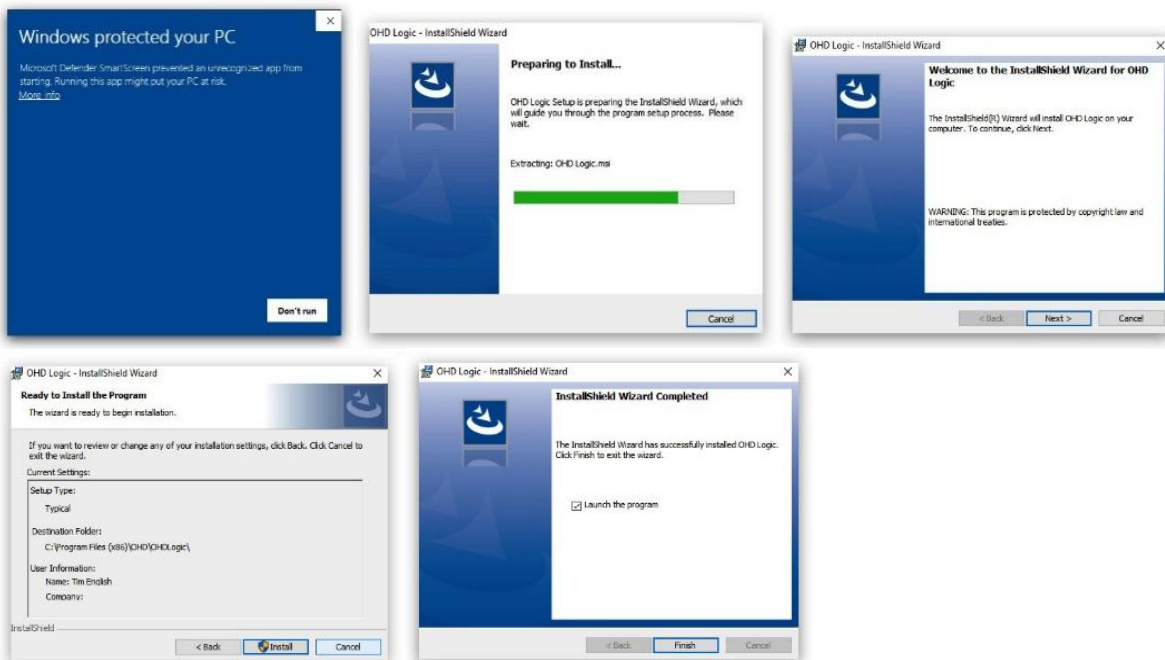

Software Updates

OHD Logic software will be updated periodically to enhance features, add features, or fix bugs. In the [Settings](#) section, there is an option to automatically receive updates. If this is not turned on, whenever the Update menu is selected, the software will check to see if an update is available and there will be an option to update or not.

Software updates will typically install "on top of" the current installation and an uninstall will not be required. However, if an uninstall is required for any reason, this will not affect the database. It is best practice with any software to back up data when updating or uninstalling a program.

Home Screen

After initial setup, most people can do any task required directly from the Home Screen. This includes running tests, adding people, adding respirators, viewing test statistics, and identifying those people who are due for testing.

Each of the modules seen on the Home Page can be collapsed by clicking on the no-view icon. When doing this, the module will become a button that goes to the right-most edge of the viewing screen. These modules will still be in operation, but they won't clutter the screen if they are not used regularly.

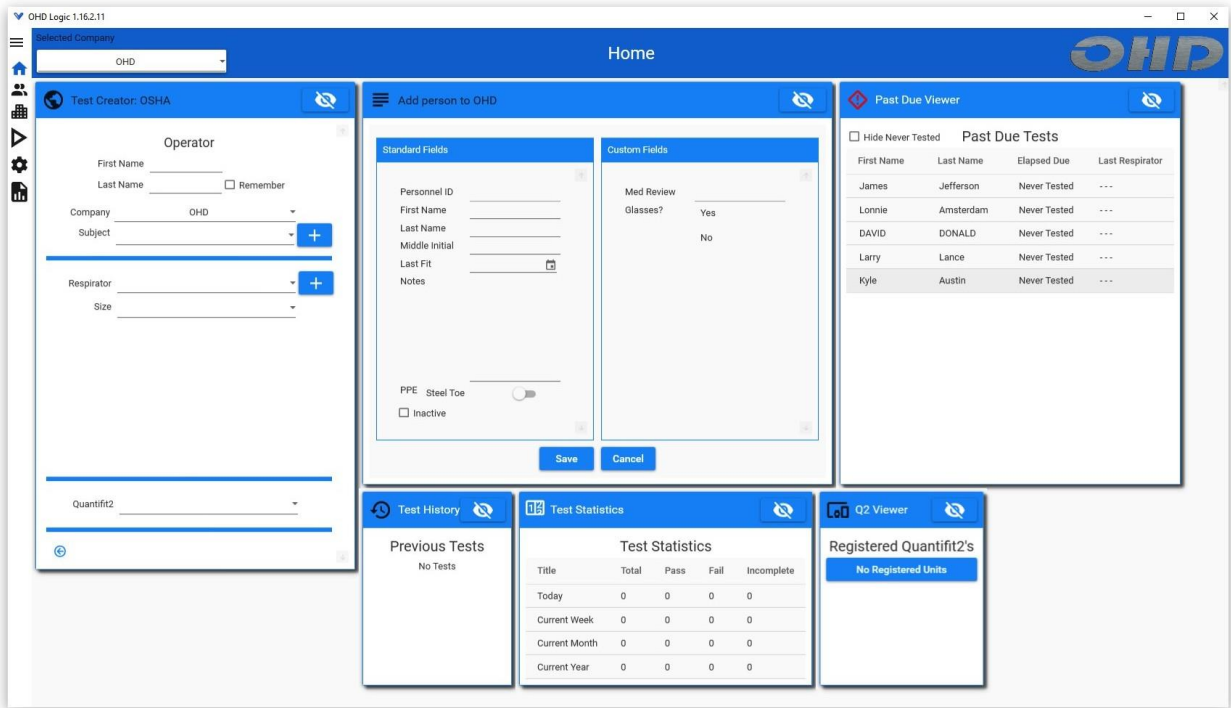

The top bar of the software displays the name of the section (Home Screen), the selected company, and the operator that is currently logged in (when the security feature is enabled). The company can be changed at any time, and if security is activated, the operator can log out of the software

Home Screen

Test Creator

To perform a fit test, it must be launched from the Test Creator. The Test Creator is a simple guide to record pertinent test information and to initiate the test. All fields must be complete for the Start button to appear.

- Operator

Add first name and last name to the operator selection.

Check the "Remember" box if the name is to be remembered throughout the current testing session.

When "Remember" is not checked, an operator's name would need to be input for each test.

- Company

Select the company from which the testing is to be performed. The company can also be selected in the title bar of the Home Screen.

- Subject

Put the computer cursor in this field and begin to type a person's name (first name, last name). There is a lookup that matches names letters are entered.

When the correct person appears in the field, move on to the respirator selection.

A person may also be found by using the field's drop-down arrow and scrolling through the list of names.

If the test subject does not appear in the list of names, click on the "+" symbol to add a person. This will bring up the Add Person screen if that screen is not already opened.

When the information has been added and the Save button is clicked, the added name will appear in the Subject field.

- Respirator

When selecting the Respirator drop-down menu, those respirators that were enabled in the [Respirator](#) section will be visible. A respirator may be added by clicking on the "+" button, which will open the Respirator Management screen. Click on the toggle switch  to add a respirator to the available list.

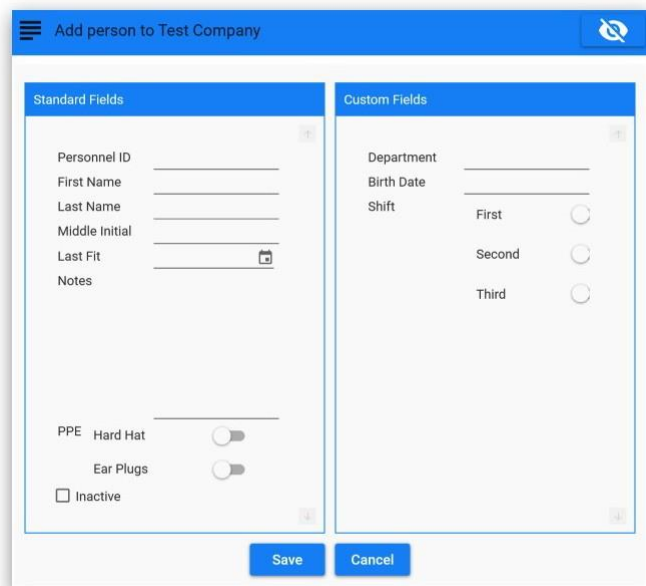
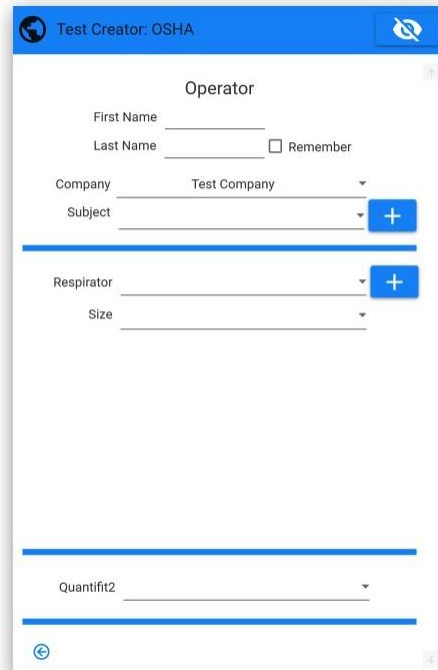

Home Screen

Select a size from the drop-down menu.

- QuantiFit2

Use the drop-down menu to select the instrument you want to use for testing.

If a QuantiFit2 has not been registered to the software, this will need to be done through the Settings/Devices menu.

If only one unit is registered, this field will be populated with that instrument.

If there is more than one instrument registered, this field will remember the last one used.



Add Person

There are various ways to enter people into the software for testing. For larger groups of people, it might be most effective to import a list of people through the Import/Export feature in the Settings/Data section. Another way is through the People section. But people may also be entered in this module on the Home Screen. The name is required, but other fields are optional according to how the data is required by the organization. PPE options are set up under the Company record and will record the PPE assigned to this person.

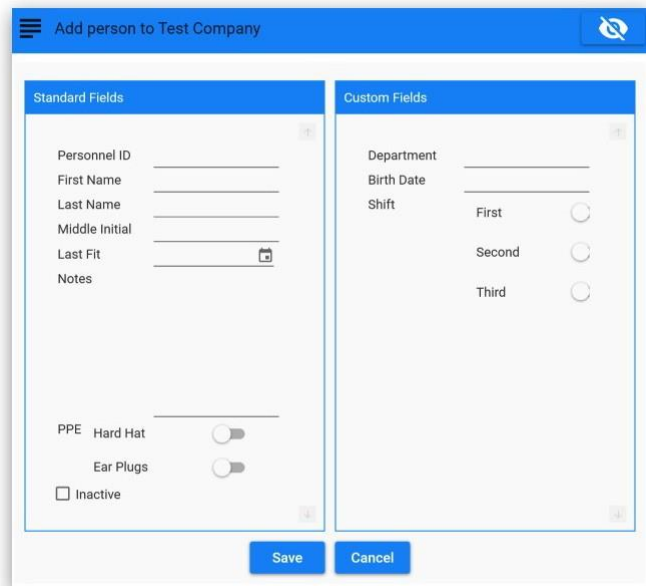

The optional fields shown in a second column, if they have been modified or changed, are regulated under Company record. Three types of custom fields can be added for record keeping:

- Field - which would have a blank field to be filled in.
- Date - for selections such as birthdate, date of hire, etc.
- List - when predetermined selections are required.
 - The list can be modified at any time. If a field is removed, the data contained in that field will not be deleted and can be seen if that field is activated again.
 - See the list options under the [Company](#) section of this manual.

Home Screen

Past Due Viewer

This tool allows the operator to quickly view those who are due for a test.

The list will show any person in the database who is within a month of needing testing.

By default, the "Hide Never Tested" box is left unchecked.

In addition to those due for testing, the list will also contain those people in the database who have never been tested. The people who have never been tested can be hidden from view when checking this option.

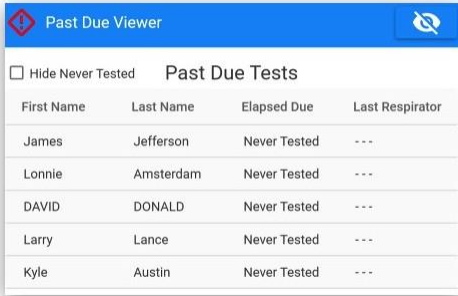

The screenshot shows the 'Past Due Viewer' interface. At the top, there is a blue header with a red warning icon and the text 'Past Due Viewer'. Below the header, there is a checkbox labeled 'Hide Never Tested' which is unchecked. To the right of the checkbox is the title 'Past Due Tests'. Below this is a table with four columns: 'First Name', 'Last Name', 'Elapsed Due', and 'Last Respirator'. The table contains five rows of data.

First Name	Last Name	Elapsed Due	Last Respirator
James	Jefferson	Never Tested	---
Lonnie	Amsterdam	Never Tested	---
DAVID	DONALD	Never Tested	---
Larry	Lance	Never Tested	---
Kyle	Austin	Never Tested	---

Previous Tests

This module will contain a list of tests listed in the order in which they were performed and recorded.

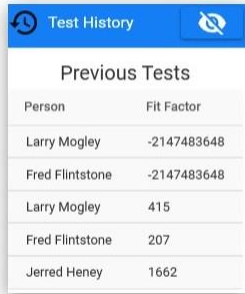

The screenshot shows the 'Previous Tests' interface. At the top, there is a blue header with a clock icon and the text 'Test History'. Below the header is the title 'Previous Tests'. Below the title is a table with two columns: 'Person' and 'Fit Factor'. The table contains six rows of data.

Person	Fit Factor
Larry Mogley	-2147483648
Fred Flintstone	-2147483648
Larry Mogley	415
Fred Flintstone	207
Jerred Heney	1662

Test Statistics

Test Statistics will show a quick snapshot of current testing.

This includes records of tests that are passed, failed or incomplete. Tests will also be categorized between the current week, month, and year.

The current week begins with Sunday and ends with Saturday.

The current month begins with the first day of the month, and the current year begins January 1.



The screenshot shows the 'Test Statistics' interface. At the top, there is a blue header with a bar chart icon and the text 'Test Statistics'. Below the header is the title 'Test Statistics'. Below the title is a table with five columns: 'Title', 'Total', 'Pass', 'Fail', and 'Incomplete'. The table contains four rows of data.

Title	Total	Pass	Fail	Incomplete
Today	0	0	0	0
Current Week	0	0	0	0
Current Month	0	0	0	0
Current Year	13	3	2	8

People

The people list shows the people in the currently selected company who have not been made inactive. The All Companies box can be checked for a list of people throughout all companies.

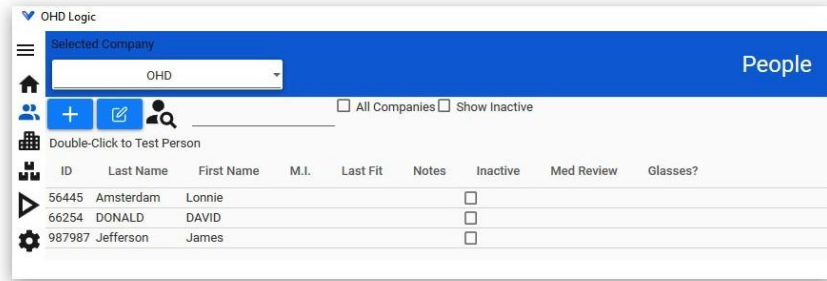

Users can be made inactive if they have left their position, or no longer require fit testing. Their records will not be deleted, but they will be hidden from view. To reactivate a person, click on "Show Inactive," select the person, and click on the Toggle Active button.

People can be added or edited on this screen. The plus sign will bring up an Add People screen, while the edit button will allow the currently selected person's record to be edited. The search field can contain any combination of letters that appear in someone's name, and that person will show up in the list.

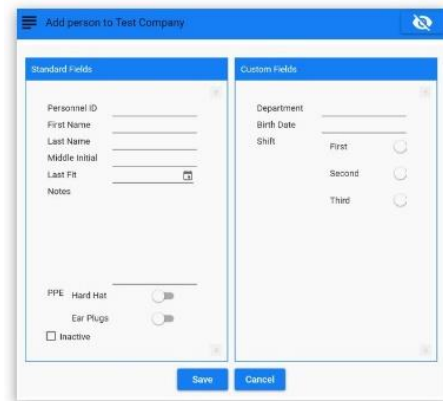

Typing "ian" will bring up anyone named Ian, as well as Brian.

Typing Brian will bring up only those people named Brian.

Typing B will bring up anyone with a "B" as a part of their name.



Sync

The Sync function is located on the People Screen.

This will allow you to sync your data from the QuantiFit2 machine to your Logic software. It will also sync whatever you have selected in Logic to your QuantiFit2 machine. If you have filtered a certain company and certain names as shown below, this is what will sync to your QuantiFit2 machine.

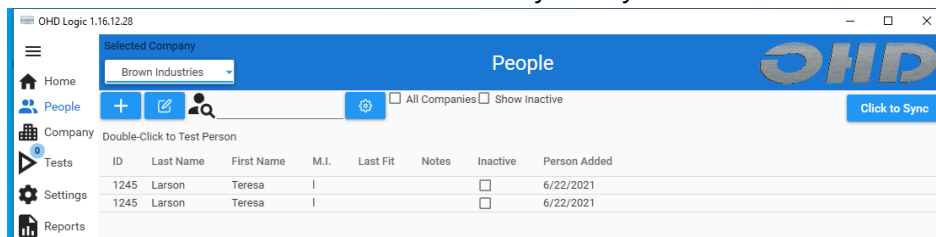
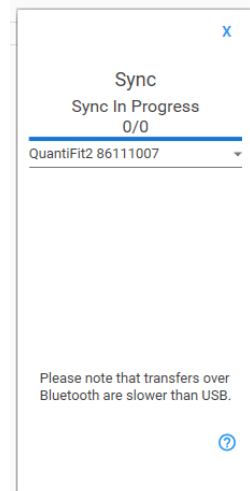
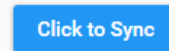

Company

Many QuantiFit2 users will have only one company, while others might have dozens, depending on the needs for testing. The purpose for a Company is to create a division within the database. The company name will appear on the top of the fit test reports. Company divisions are not necessary and are only for convenience. The number of people that can be listed in a company is virtually unlimited. A shared instrument can have a company for each entity that is using the instrument.

A person can be transferred to any existing company.

Add Company Screen

- The required field is the company name, the rest is for record keeping
 - Add PPE that might be assigned to the individual
 - Custom fields include fields, dates, and lists
- A field is an open text box
A date will show a calendar
A list allows the operator to create list items which permit multiple selections

Field Name	Field Type	Required
Department	Field	<input type="checkbox"/>
Birth Date	Date	<input type="checkbox"/>

Configure List

Shift: List Third First Second

+ - Add Remove

Tests

The test screen is where any active test can be viewed. This may be one test, or it may be for an operator who is controlling multiple instruments. The QuantiFit2 allows users to run countless machines simultaneously through the OHD Logic software (as many machines as an operator is capable of overseeing), with flexibility on the start time for any test. This screen also contains a Test Creator to begin new tests while viewing current tests.

Test Creator: OSHA

Operator

First Name: Jack
 Last Name: Cornell Remember

Company: OHD
 Subject: _____

Surrogate?
 Respirator: _____
 Size: _____

Quantifit2: _____

Tests

Jerred Heney APR Half - Test Running

Mask Name: 3M 6000 Series
 CP: 0.58
 Passing FF: 100

Step	FF	Status
Face forward	173	Test Passed
Bend over	187	Test Passed
Shake head	0	Test Running
Re-don 1	0	Waiting
Re-don 2	0	Waiting

Challenge Pressure graph: Shows pressure rising to 0.58 and stabilizing.

Gary Palomino APR Half - Waiting

Mask Name: 3M 6000 Series
 CP: 0.58
 Passing FF: 100

Step	FF	Status
Face forward	0	Waiting
Bend over	0	Waiting
Shake head	0	Waiting
Re-don 1	0	Waiting
Re-don 2	0	Waiting

Challenge Pressure graph: Shows a flat line at 0.58.

Larry Mogley APR Half - Waiting

Mask Name: 3M 6000 Series
 CP: 0.58
 Passing FF: 100

Step	FF	Status
Face forward	0	Waiting
Bend over	0	Waiting
Shake head	0	Waiting
Re-don 1	0	Waiting
Re-don 2	0	Waiting

Challenge Pressure graph: Shows a flat line at 0.58.

Tests

The testing sequence

When initiating a test from Logic, the software will display the inhalation valve message reminder, and then display the tube connection instructions. These two screens can be turned off by checking the box next to "Hide these messages next time."

The test subject will view a message that says, "Device is in remote mode. Please wait until the Operator sets up the test."

If the daily verification check has not been completed for the day, the QuantiFit2 will prompt the user to perform this check.

When the test is initiated, the test subject will see "Please review this information. If correct, press the blue arrow to continue." (Name, size respirator, parameter, surrogate).

The next screen will prompt for Operator's signature. Once signed, it will store the Operator's signature indefinitely in Logic software, until Operator is deleted. Test subject will then follow the QuantiFit2 on-screen instructions to complete the test.

If a test step should fail for any reason, the operator will be notified on the software test screen and be given an option to retry the step or save it (if a fit factor was calculated).

There are some troubleshooting suggestions that can be seen by clicking on the question mark in the upper left of the test screen next to the Delete button. See the [Troubleshooting](#) section for more information.

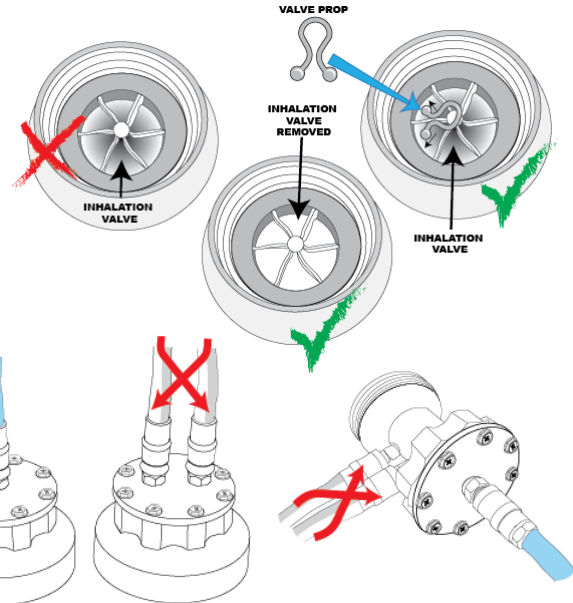

Software Settings

Security

The security mode is turned off by default but can be enabled at any time. Click on the check box, and a message will appear to make sure it is intentional that the security function is being turned on.

If the Security feature was used in this database at any time in the past, then Administrator(s) will already exist. If this is the case, make sure the administrator credentials have been recorded and are accessible. If no Administrator was ever created, the operator will be given an option to create a login.

After the login is created, the user immediately will be required to log in to use the software.

Once Security is turned on, and an Administrator is logged in, the Administrator can then add other Operators and/or Administrators.

Administrator vs. Operator

When Security is activated, to gain access to the software, a person will need login credentials. These credentials either will be assigned to Operator or Administrator status.

- Operator status allows a person to log into OHD Logic and run tests, reports, add people and all the regular functions of a fit testing program.
- Administrators are unique from Operators in that Administrators can gain access to all the setup items.

If the password is lost or forgotten and nobody can gain access to the software or to the Settings functions, OHD must be contacted, +1-205-980-0180, option 4, or techsupport@ohdglobal.com.

The person requesting login information must be able to prove that they have authority to control the software (as determined by OHD's tech support team). OHD claims no liability as to the privacy of a customer's data.

Software Settings

Options

The options section offers flexibility as to how the software operates.

- **Default View** allows the Administrator to select which main screen should be shown when the software is launched.
- **Base Theme** allows the Administrator to change the software view to light mode or dark mode.
- **Select Regulations** allows the operator to choose a testing regulation other than the one that was selected upon initial setup.
- **Allow Auto Updates** will cause the software to check for updates each time the software is opened .
- **Login Timeout** is defaulted to Off. By selecting a time increment, this will determine how long the software can remain untouched before it automatically logs the Operator or Administrator out.
- **Date Format** allows the Administrator to select the type of date format preferred. (MM/DD/YYYY, DD/MM/YYYY, YYYY/MM/DD)
- **Allow Reporting** When this feature is allowed, the software will send errors to OHD. This will help OHD to continue to refine the software, and it may help with troubleshooting issues.
- **Valve Prop Messages** will universally turn the valve prop message on or off regardless of respirator being used.
- **Default Auto Start** Each time a test starts, it will always default to using the auto start feature unless this option is not turned on. If the feature is not turned on, it will remember the last used setting.
- **Save Changes** to make sure that any changes will take effect.
- **Export** will allow the Administrator to export these default settings and import them into another database on another PC.
- **Restore Defaults** will change the above settings to the way that they were upon the initial install of OHD Logic.



Devices

Connecting the Quantifit2 to Logic

Under the settings section, click on Devices. You can connect via USB or Bluetooth. Once your serial number appears below this button, click on Register button, then it will appear on the right as shown below. To test connection, highlight your serial number and click the Test connection button to confirm.

When connecting via Bluetooth, make sure to pair the device by opening Logic software and going through the steps above to register your device.

The screenshot displays the 'Devices' section of the Logic software interface. On the left is a vertical navigation menu with options: Devices, Security, Options, Respirators, Data, Update, and About. The main area is split into two panels. The left panel, titled 'Register New QuantiFit2's', contains a 'Find QuantiFit2's' button, a 'Stop' button, and a 'Register' button at the bottom. The right panel, titled 'Previously Registered Devices', features a 'Test Connection' button, a 'Remove Device' button, a 'Restart Unit' button, and a 'Rename' button. Below these buttons is a table with the following data:

Name	Serial	Last Used	Last Calibration	Last Daily
QuantiFit2 86111007	1007	1/1/0001	4/20/2021	6/8/2021

Respirators

Respirator List

OHD Logic Software comes with a pre-populated list of respirators. Every effort is made to keep this respirator list up to date, but if a respirator that is being used does not appear on the list, it may be added. OHD would like to be notified if a respirator is not listed (techsupport@ohdglobal.com) so that we may update our list, which will be distributed to our customers as updates are completed.

Find the respirator manufacturer and model that will be used for testing and turn that selection on with the toggle switch.

When a respirator is turned on, it will become part of the selectable respirator list when performing a fit test. When respirators are no longer being used, the respirator may be "turned off." This will in no way affect previous tests that have used this respirator.

To create a new respirator:

- Click on the New button.
- Type in the Manufacturer and Model Name.
- Select Type of respirator (APR-Half, APR-Full, PAPR, Gas respirator, and SCBA). Each respirator will have different testing parameters according to which regulation has been selected for your testing.

An image may be uploaded so that the respirator can be seen when selected. The image target size ideally should be 240 X 370 pixels, or it will be sized when importing.

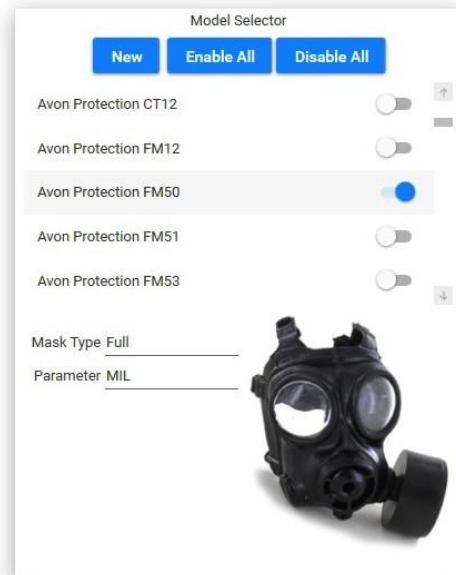

Respirator Sizes

The default respirator sizes that are pre-programmed into the software include: Small, Medium, Medium-Large, and X-Large.

The respirator sizes module allows the operator to add additional respirators sizes if the need should arise. This could include sizes such as One-Size-Fits-All, X-Small, etc. The operator may also delete sizes of respirators that are not a size used by a specific respirator manufacturer. This would prohibit operators from selecting the wrong size by mistake.



Respirators

Parameters

Parameters define how each respirator type is tested. Upon initial setup, a regulation was selected. This selection can be changed in the settings.

Select the mask type, and the appropriate parameters will be displayed.

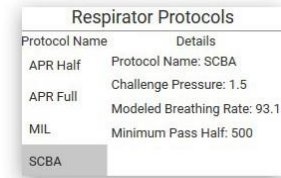

Protocol Name	Details
APR Half	Protocol Name: SCBA Challenge Pressure: 1.5
APR Full	Modeled Breathing Rate: 93.1
MIL	Minimum Pass Half: 500
SCBA	

If for some reason, a change is needed for a specific regulation (minimum passing fit factor, challenge pressure, etc.), An Administrator can create or duplicate an existing regulation, and make the required changes. This is highly discouraged as the regulations are in place as required. Regulations will be added or modified to the software when changes or updates become available.

When clicking on the Update icon, The software will give a notification stating whether there is a software update available or not. In the Setup section of the Setup options, there is an option to turn on or off the ability for the software to automatically update. With the auto update turned on, whenever there is a new release, the operator will be prompted to confirm that he or she wants the update to occur.

About

In the About section, information is included for:

OHD Contact Information

Address: 2687 John Hawkins Pkwy, Hoover, AL 35244, USA Phone: +1-205-980-0180

Website: www.ohdglobal.com

Email: sales@ohdglobal.com, techsupport@ohdglobal.com

Software version

Quick Links to useful websites

Reports

Report Settings

You can add your logo to your reports by clicking on Change Logo button and selecting your image file. If you click Reset Logo, it will revert to the default OHD logo. There are several types of reports that can be produced from OHD Logic.

- **Fit Test Report:** The report that would print at the end of a fit test which contains all the pertinent information to be recorded for an individual test.
- **Fit Test Summary:** A report including the summary for a selected company or a specific period of testing.
- **Fit Test Card:** This report will print to a card printer so that people may carry a record of their fit test.
- **Fit Test Log:** The Fit Test Log Report prints a snapshot of Fit Tests. The user can choose which columns appear on this report. This is confined by the space limitations of the width of the printed page.

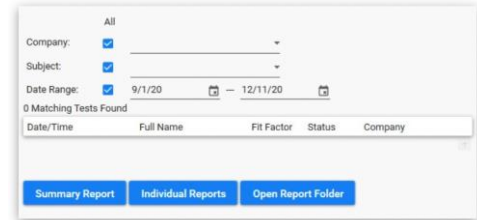

When a report is saved, it can be found as a PDF inside the Reports Folder. Click on the button to open the Reports Folder.

Database Functions

○ Data Import

The QuantiFit2 gives you the capability to import a database from another computer, import Portacount files, as well as import csv files from FitTrack Gold and Personnel & Test data lists. Follow the file structure for each import in the  section of the Settings-> Data -> Import section.

○ Data Export

You can export your entire database that can be imported to another computer. Choose Export button next to OHD Logic Database. It will prompt you to confirm the export. Then save your file (.ldb) to a USB drive. Then you will be able to import this file to another computer using the Import button.

You also have the option to export select areas of your database using the blue buttons next to Export CSVs

Troubleshooting

Graph Behavior:

The way the traceline of the graph displays during a test may be very helpful to understand a test step. Below you will find images with common traceline drawings.

Inhalation valve not removed or propped open

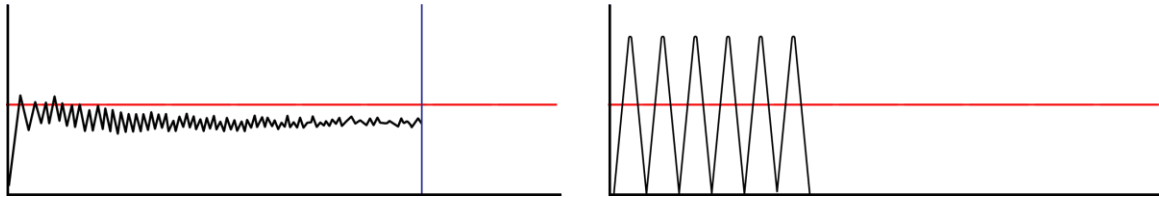

When the inhalation valve is interfering with the fit test, this is what the traceline will look like. On the adapter side with the two tubes attached, the airway needs a clear path into the respirator. If the way is not clear, the above graph will appear.

1. The inhalation valve can be propped open from the outside of the respirator before the adapter is connected.
2. Use an OHD valve prop to keep the valve intact and open during the fit test (pictured here).
3. If a valve prop is not available, other materials may be used. Take care not to damage the valve when inserting an object to prop it open.
4. For some respirators, it might be easier to remove the inhalation valves before the test, and then replace them at the end of the fit test.



HIGH LEAKAGE - Large leak is measured

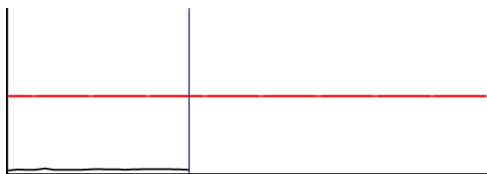

When the traceline does not lift above the bottom of the graph, this indicates that the QuantiFit2 has detected a large leak in the respirator. This would be related to a leak in the integrity of the respirator, a poor donning, or poor fit of the respirator.

1. Check all tubing connections for secure attachment and confirm there are no holes or tears.
2. Check to ensure that the QuantiFit2 respirator adapter is properly attached to the respirator. Look for cross-threading, loose connection, etc.
3. Check respirator for proper tightness to the face and check that no hair, beard stubble, unique face characteristics, or other objects inhibit a good face-to-facepiece seal.
4. Try a different respirator. Many respirators *seem* to fit well but are not properly sized to a specific wearer. In other cases, a different size or style may be better suited for the individual wearer.

Troubleshooting

Failure to reach challenge pressure

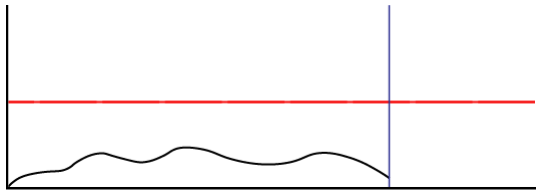

Like the large leak, when the traceline does not reach the challenge pressure line, this indicates that there is a moderate leak between the QuantiFit2 and the person wearing the respirator.

1. Check all tubing connections for secure attachment and confirm there are no holes or tears.
2. Check to ensure that the QuantiFit2 respirator adapter is properly attached to the respirator. Look for cross-threading, loose connection, etc.
3. Check respirator for proper tightness to the face and check that no hair, beard stubble, unique face characteristics, or other objects inhibit a good face-to-facepiece seal.
4. Try a different respirator. Many respirators *seem* to fit well but are not properly sized to a specific wearer. In other cases, a different size or style may be better suited for the individual wearer.

Perfect graph but still fails



When the graph looks like a perfect fit test, but the fit factor is too low to pass, this means that there is a leak, but it's not a huge leak. This would be related to a leak in the integrity of the respirator, a poor donning, the fit of the respirator, a fault in an adapter, or a dirty exhalation valve in the respirator. Be sure to clean the exhalation valve with a moist wipe. As in other leakage situations (see HIGH LEAKAGE), check all tube connections, adapters, and adapter connections to respirators.

1. Check for proper tension of respirator to face.
2. Try a different size or different respirator.
3. Check fit test adapter for leaks. Check Troubleshooting section 3. Adapter Fault below. OHD provides this as an optional service during yearly calibration

Troubleshooting

Traceline way above challenge pressure line

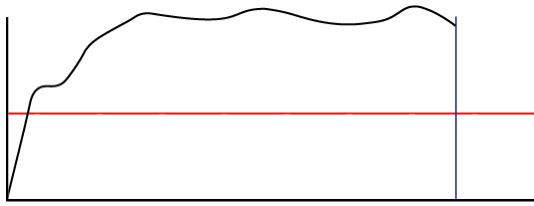

The QuantiFit2 traceline goes opposite of the direction of the pressure. If the line is above the challenge pressure line, that means that there is too much negative pressure. In this case, a test subject is most likely continuing to draw a breath in during the test. Movement by the person being tested needs to be minimized. Actions such as swallowing or opening the mouth, can adversely affect the pressure sensor and will be indicated by an erratic traceline.

1. Air inhalation or exhalation, even slightly, creates dramatic changes within the respirator. Instruct the test subject to maintain breath holding during the test measurement.
2. A test subject may be unable to stop the flow of air through the nose while holding his or her breath. A nose clip can assist the subject (be sure that the nose clip does not interfere with the fit of the respirator).
3. Improper breath hold. Instruct the user to relax, take a comfortable breath and hold as if going under water.

The pressure inside the respirator drops during the test

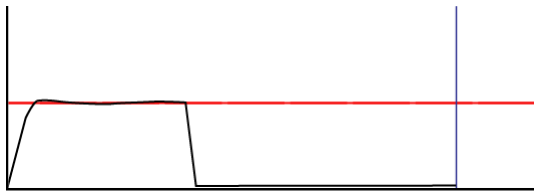

This graph would indicate that the challenge pressure was achieved, but during the test, a leak source opened. This could be the result of an exhalation valve that is in poor condition, or from the test subject moving his or her head, or subject stopped holding their breath and creating a leak in the seal.

1. Clean the exhalation valve in the respirator
2. Instruct subject to take a normal breath in, and hold as if going under water
3. Examine the condition of the respirator

Troubleshooting

Large up-and-down spike during the test

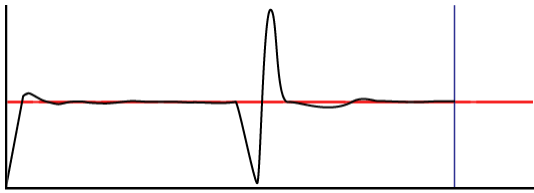

When the traceline goes way down and then way up, this would indicate that the test subject swallowed or stopped holding their breath during the test.

1. Instruct the test subject to remain calm and not to swallow or move during the test measurement.
2. Remove distractions from the area that may be interfering with the test (e.g., other test subjects making the test subject nervous or laugh during a test).

Failing Fit Factors:

Low Fit Factors

When fit factors are consistently low, the respirator may be a poor fit for that person. If the graph looks normal and the fit factor is low, that means that the QuantiFit2 is successful in meeting the challenge pressure, but a large volume of air is required to be removed to achieve that targeted pressure, which means the leak is too large.

When the leak rate is large, the graph can still look somewhat normal. The QuantiFit2 will often be able to keep up with the leak and give a good test result, although the leak is too large to yield a passing fit factor.

1. As in other leakage situations (see HIGH LEAKAGE), check all tube connections, adapters, and adapter connections to respirators.
2. Check for proper tension of respirator to face.
3. Be sure that the mask is centered on the head, and that the straps are pulled equally on both sides.
4. Try a different size or different respirator.
5. Check adapter for leaks Check Troubleshooting section 3. Adapter Fault below. OHD provides this as an optional service during yearly calibration.

Fit Factor of 0

When the fit factor equals 0, this indicates that the QuantiFit2 was not able to sustain the challenge pressure long enough, or that the traceline movement was so great that the QuantiFit2 did not receive accurate data to calculate a leak rate or fit factor.

1. Movement by the person being tested needs to be minimized. Actions such as swallowing, opening the mouth, and moving the tongue can adversely affect the pressure sensor.
2. Air inhalation or exhalation, even slightly, creates dramatic changes within the respirator. Instruct the test subject to maintain breath hold during the test measurement.
3. A test subject may be unable to stop the flow of air through the nose while holding his breath. A

Troubleshooting

nose clip can assist the subject (be sure that the nose clip does not interfere with the fit of the respirator).

4. Improper breath hold. Instruct the user to relax, take a comfortable breath and hold as if going under water.

Trouble Passing Fit Test

What do I do when people are not passing a fit test?

This problem could include several variables, but most likely would fall into three categories: instrument failure, respirator fit, or adapter fault. If it's a one-time problem when other people can pass, the answer simply may be that the respirator is not a good fit on the subject. When several subjects can't pass, look at the other variables:

1. Instrument Failure

- a. You must do the Daily Verification Check at the beginning of each day.
- b. If the QuantiFit2 passes the daily verification procedure, this assures that the instrument is operating properly and measuring within tolerance.
- c. If the QuantiFit2 is not able to complete the Daily Verification Check. Please contact OHD Tech Support to troubleshoot before sending in for service.

2. Respirator/Fit Fault

- a. The Operator must first determine that there is a proper fit. Any facial hair, hair getting anywhere under the respirator seal, temple hair too far forward, sunken temples or facial scarring, protrusions, or blemishes, having the respirator too loose or too tight, all can be reason enough to keep the QuantiFit2 from pulling a negative pressure within the respirator. There are other obstacles that can come into play which are too numerous to list. With more experience fit testing, it's easier for one to see potential problems with fit.
- b. To further check on the respirator fit, do a user seal check for 10 seconds. Press the Seal Check button located on the test screen and take in a breath and hold the pressure allowing for plenty of suction on the respirator. If after 10 seconds the respirator "drops" when releasing the Seal Check button, this indicates a good fit. If after the same procedure there is no drop or "falling away" from the face, this indicates that all the air leaked out through a leak source and is the reason for a failed test step.
- c. Exhalation valves may be dirty or creased allowing air to be pulled into the respirator. While the inhalation valves must be removed or propped open, the exhalation valve must remain in place and maintain a good seal. Clean the side of the valve that faces the interior of the respirator. This can be done with water and will remove any small obstruction that is keeping the valve from closing in an air-tight manner.
- d. On the respirator, the apex of the head straps should sit on the crown of the head and not off to one side or the other.
- e. Check the manufacturer's recommendation for properly donning a respirator and ensure that the user has been properly trained in donning that respirator as part of the regulations. All straps must be pulled with equal tension at each point.

Troubleshooting

3. Adapter Fault

- a. The adapters must be kept clean and in good shape.
- b. Disconnect and reconnect all tubes to make sure the connectors “snap” securely into place. Hold the assembly by the tubes rather than the metal connector.
- c. To verify the adapter is air-tight, connect only the blue tube to the adapter with the single tube connection. Submerge the adapter and tube connection completely under water. Then press and hold the SEAL CHECK button for at least 5 seconds. Repeat this several times. If bubbles like boiling water are seen coming from the adapter, there is a leak in the diaphragm or in the eight screws holding the top plate on. Replace the diaphragm and tighten screws firmly. Conduct the test again to ensure no bubbles are seen.
- d. Check all screws and connectors. If the screws on the top of the adapter are not tight, or if the tube connector ports can be turned by hand, this means they are not tight enough and may be introducing a leak into the system.

Daily Verification Errors

The Daily Verification normally functions to completion without any intervention from the Operator. However, occasional problems may arise. The calibration procedure may stop abruptly or display an error message.

Possible Problems:

- Something has blocked or partially obstructed the leak orifice on the Dual Tube Assembly and has rendered the tube out of tolerance.
- The transducer needs factory calibration.
- Check all tubing for holes or tears.

Possible Solution:

- Turn QuantiFit2 off, wait 15 seconds, power on, and retry Daily Verification.
- Remove and replace all tubes.
- Contact OHD Tech Support to evaluate problem or to arrange return to OHD Service Department.

Bluetooth Connection Issues

If you are having issues connecting via Bluetooth, make sure you are pairing from the Logic Software and not through Windows settings. Next check that in your Windows Bluetooth settings that the button is set to “On”

Troubleshooting

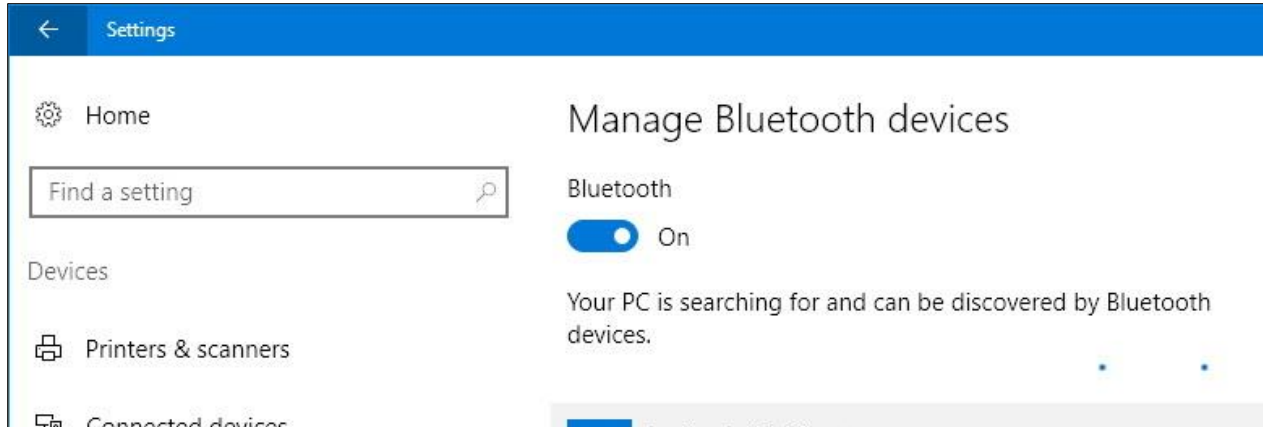

Make sure your device is turned on. Then turn off the QuantiFit2, wait a few seconds, then turn back on. Check to make sure it is not too close to any other USB devices. Sometimes unshielded USB devices can interfere with Bluetooth connections.

Should service be needed for your instrument, contact the OHD Service Department. For those instruments outside the U.S.A., contact OHD to find the nearest service center.

CAUTION: The QuantiFit2 is intended to be serviced only by authorized service personnel. Service procedures should only be performed by qualified technicians.



If the QuantiFit2 appears to be tampered with, this may render the warranty null and void. For service and operation questions, contact OHD: service@ohdglobal.com, +1.205.980.0180.

Calibration and Maintenance

To ensure that the QuantiFit2 is working properly and within specification, a daily verification must be performed before each day of testing, and an annual factory calibration must be done once each year.

Reasons for Annual Maintenance & Calibration:

The QuantiFit2 is a highly accurate precision instrument that uses electronic pressure sensors to detect minute changes to very low levels of negative pressure to an accuracy of +/- 0.25%. To ensure the instrument operates at the parameters for which it is designed, OHD requires the QuantiFit2 to receive annual maintenance and calibration at an authorized service facility.

- OSHA Mandate – 29 CFR 1910.134 Appendix A Part I.C.1.(b) – “The employer shall ensure that QNFT equipment is kept clean and is maintained and calibrated according to the manufacturer’s instructions so as to operate at the parameters for which it was designed.”
- Best Practice – Annual calibration and maintenance is the accepted industry standard for Industrial Hygiene and Occupational Health instrumentation.
- Reliable Results – The QuantiFit2 is a precision instrument that is used to help ensure employee safety. Critical decisions are made based on the results provided by the QuantiFit2. All precision instruments require some degree of calibration to ensure the measurements are accurate.
- Limits Liability – Complying with the manufacturer’s guidelines establishes good faith efforts towards employees’ health and safety. Failure to comply with established safety protocols could be viewed as negligent.
- Extends Service Life – The heart of the QuantiFit2 is a mechanical piston type pressure engine. Included in the calibration procedure are pressure engine checks. The pressure engine is completely disassembled, cleaned, and lubricated where warranted.
- Lifetime Powertrain Warranty – Receiving annual calibration extends the lifetime powertrain warranty on the QuantiFit2.
- Upgrades – The calibration process includes upgrades to the latest firmware versions and modifications as needed.
- Confidence – Our NIST (National Institute of Standards and Technology) traceable calibration assures that the unit is operating properly within accepted parameters.

Appendix A: Specifications

General

Input Voltage..... 12VDC, Center Positive, 3A Max
 Power Supply.....Universal, 100-240VAC, 50/60Hz 1A Max
 Overvoltage Category 2
 Operating Temperature (max based on [configuration](#)) 5 to 45°C
 Humidity Range 20 to 80%, Non-Condensing
 Setup Memory.....20 GB
 Size..... (H) 11 x (W) 4.4 x (D) 15 inches
 Weight.....8.5 lbs

Dynamic Range

Leak Test Measurement.....2-5000 cc/min
 Resolution0.1 cc/min
 Fit Factor Computation..... 6-53,000
 Resolution 1

Pressure Sensor - Fit Testing

Pressure Range.....0-20 inches of water
 Resolution 0.01 inches of water
 Accuracy ± 0.25% FS

Pressure Sensor – Pump

Pressure Range.....0-20 PSI
 Resolution0.1 PSI
 Accuracy ± 2.5% FS

Instrument Accuracy

Challenge Pressure ± 5%
 Leak Rate Measurement ± 3% or ±3 cc/min (whichever is greater)
 Display.....800 x 480 pixels
 TouchscreenCapacitive Touch

Environmental

Pollution Degree..... 2

USB Interface

4 Type A Ports (Keyboard, USB Memory, Printer)..... 4
 1 Type B Port (PC Communication)..... 1

PC Requirements for OHD Logic Software

Operating System Windows 10 or newer
 Processor Speed 1.0 GHz or greater
 RAM..... 1 GB or greater
 Disc Space..... 16 GB

Certifications

- UL61010-1/CSA C22.2
- EN 61326-1:2013
- FCC Part 15 Subpart B
- Industry Canada ICES-003 Issue 6

Appendix B: Import Personnel Template

To import a list of names directly into the QuantiFit2, an Excel spreadsheet must be filled out with specific headers (see below). Fields can be empty and will be empty on the unit when imported. After populating the spreadsheet, save to a USB drive. Insert the USB drive into the back of the QuantiFit2 machine. On the Home screen, click on People/Test button. Then click the green down arrow button and the csv files will display from the USB Drive. Highlight the file and click the green checkmark button, then confirm you want to add users to the QuantiFit2.

	A	B	C	D	E	F	G	H
1	first name	middle	last name	id	company	note		
2								
3								
4								
5								
6								
7								
8								
9								
10								
11								
12								

Appendix C: Terminology

Air-purifying respirator (APR) a respirator with a filter, cartridge, or canister that removes specific air contaminants by passing ambient air through a purifying element.

Atmosphere-supplying respirator a respirator that supplies the user with breathing air from a source independent of the ambient atmosphere and includes supplied-air respirators (SARs) and self-contained breathing apparatus (SCBA) units.

Condensation Nuclei Counting (CNC) method of Quantitative fit testing (QNFT) also known as ambient aerosol which measures aerosol concentration inside the breathing zone of a respirator and outside of the respirator with the use of a probe. The aerosols measured inside the respirator are assumed to be the result of leakage.

Controlled Negative Pressure (CNP) method of Quantitative fit testing (QNFT) that pulls and maintains a negative pressure inside a respirator by removing, and directly measuring, any air that leaks into the facepiece.

Fit factor a numerical representation of the fit of a respirator to a specific individual; typically estimating the ratio of the concentration of a substance in ambient air to its concentration inside the respirator when worn.

Fit test the use of a protocol to qualitatively or quantitatively evaluate the fit of a respirator on an individual.

Powered air-purifying respirator (PAPR) an air-purifying respirator that uses a blower to force the ambient air through air-purifying elements to the respirator inlet covering.

Pressure demand respirator a positive pressure, atmosphere-supplying respirator that admits breathing air to the facepiece when the positive pressure is reduced inside the facepiece by inhalation.

Self-contained breathing apparatus (SCBA) an atmosphere-supplying respirator for which the breathing air source is designed to be carried by the user.

Supplied-air respirator (SAR) or airline respirator an atmosphere-supplying respirator for which the source of breathing air is not designed to be carried by the user.

User seal check an action conducted by the respirator user to determine if the respirator is properly seated to the face.

Appendix D: CNP Diagram

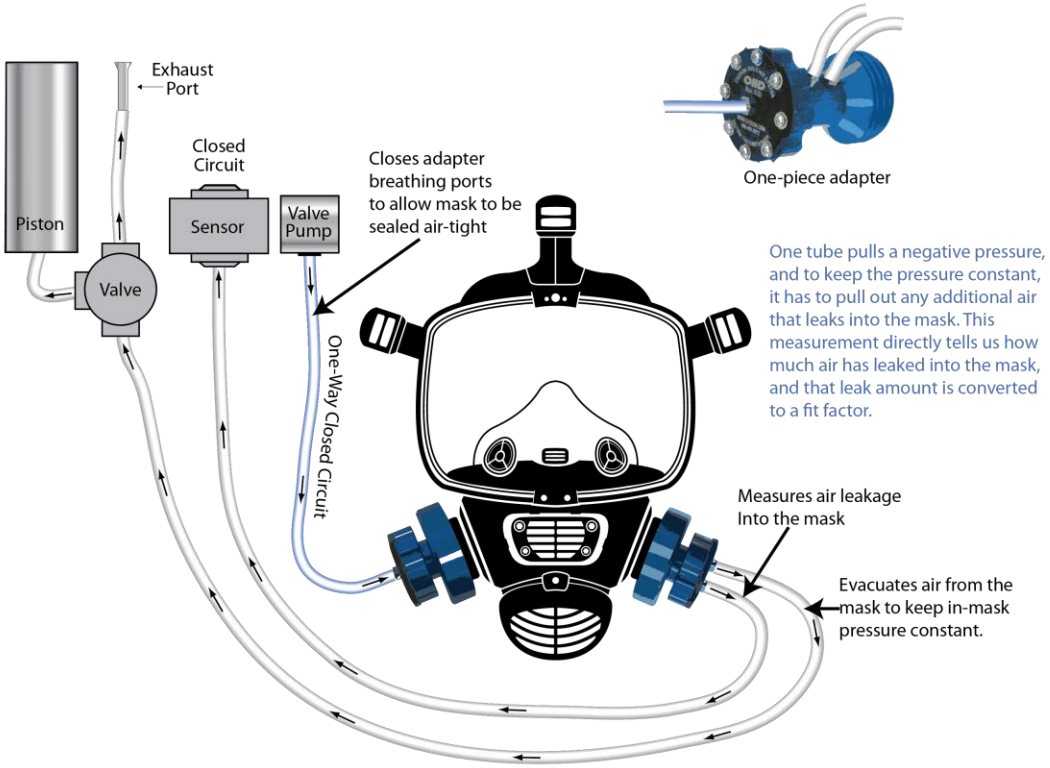

Appendix E: Regulations

Links to select regulations are shown below. Please ensure you are following all applicable standards, regulations, and guidelines.

OSHA (Occupational Safety and Health Administration)

[1910.134 - Respiratory Protection. | Occupational Safety and Health Administration \(osha.gov\)](#)



CSA (Canadian Standards Association)

[CAN/CSA-Z94.4-18 | Product | CSA Group](#)



UK-HSE (Health and Safety Executive)

[Guidance on respiratory protective equipment \(RPE\) fit testing - INDG479 \(hse.gov.uk\)](#)



ISO (International Standards Association)

[ISO - ISO 16975-3:2017 - Respiratory protective devices — Selection, use and maintenance — Part 3: Fit-testing procedures](#)



Appendix F: Fit Test Adapters

Fit test adapters are required to create an interface between the QuantiFit2 and the respirator. These adapters are inserted where the filters, cartridges, or regulators mount to the respirator. Each respirator manufacturer has its own unique cartridges, filters, or regulators to attach to their models. OHD matches the connections which will allow an interface.

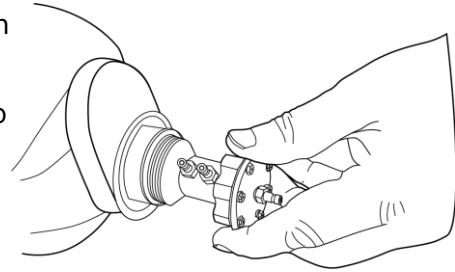

In the case of an SCBA, the respirator might be required to be converted to an air-purifying respirator.

OHD testing adapters must be maintained with care. Any dents or cracks that can occur will lose the ability to keep an air-tight seal, which would make it inadequate for testing.



Adapters can come in a one- piece or two-piece arrangement called "kits." The two-piece kit is for the bayonet connection, or connections on either side of the respirator. These are used mostly for air purifying respirators. The one-piece adapters take the place of a gas filter or SCBA connection and are typically used on those types of respirators.

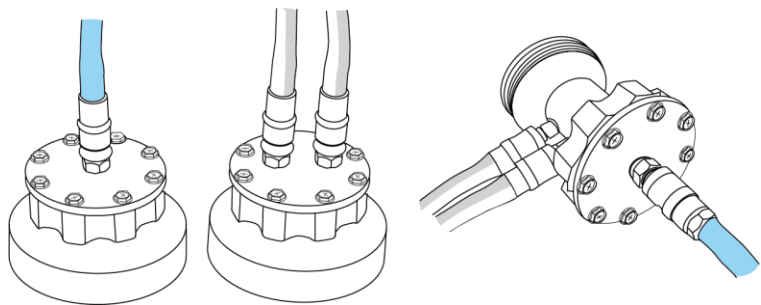

When attaching the hose assembly for testing, the blue tube always connects to the single port, and the gray and transparent hoses connect to the two ports side-by-side. For the gray and transparent tubes, it does not matter which connector gets which tube if the blue connects to the single port.

Adapters can be cleaned or disinfected in various ways. A disinfectant spray can be used, or the adapter may be submerged in a disinfectant liquid solution. The adapter must be completely dry before the next use.

To view the most updated [adapter list](#), visit the OHD website, www.ohdglobal.com.

To troubleshoot the fit test adapters, see [Adapter Fault](#) in the Troubleshooting section.

OHD



QuantiFit2[®] MANUAL

Contact Us:



www.OHDGLOBAL.com
techsupport@ohdglobal.com



+1 205.980.0180

Table of Contents

Introduction	2
How the QuantiFit2 Works	4
Instrument Setup	5
Startup Wizard	9
Navigation	11
Performing a Test	16
Reports	18
Daily Verification	19
Onboard Settings	20
OHD Logic	24
Software Updates	26
Home Screen	27
People	31
Company	32
Tests	33
Logic Settings	35
Devices	37
Respirators	38
Reports	40
Troubleshooting	41
Calibration and Maintenance	47
Appendix A: Specifications	48
Appendix B: Import Personnel Template	49
Appendix C: Terminology	50
Appendix D: CNP Diagram	51
Appendix E: Regulations	52
Appendix F: Fit Test Adapters	53

Introduction

© All rights reserved. No parts of this work may be reproduced in any form or by any means - graphic, electronic, or mechanical, including photocopying, recording, taping, or information storage and retrieval systems - without the written permission of the publisher. OHD provides this electronic copy which may be printed only for our customer's use. Products that are referred to in this document may be either trademarks and/or registered trademarks of the respective owners. The publisher and the author make no claim to these trademarks.

While every precaution has been taken in the preparation of this document, the publisher and the author assume no responsibility for errors or omissions, or for damages resulting from the use of information contained in this document or from the use of programs and source code that may accompany it. In no event shall the publisher and the author be liable for any loss of profit or any other commercial damage caused or alleged to have been caused directly or indirectly by this document. For further information, please contact the manufacturer:

OHD, LLLP

2687 John Hawkins Pkwy | Hoover, AL 35244 | U.S.A

+1.205.980.0180 | www.ohdglobal.com

sales@ohdglobal.com | techsupport@ohdglobal.com

Welcome

The QuantiFit2® can be used standalone or with OHD Logic software. When testing without a computer, all reports and test data may be retrieved from the instrument. Data can be imported into Logic software. The instrument is not compatible with FitTrack Gold, which comes with the legacy Quantifit. However, data from FitTrack Gold can be imported into OHD Logic software. The QuantiFit2 comes with an external power supply and can be powered by an optional battery. The QuantiFit2 has an optional removeable/rechargeable battery pack. Only the OHD battery pack Part number FTK 3010-4023 may be used with the QuantiFit2. Go to <http://www.ohdglobal.com> for information on purchasing the battery pack.

Safety and Environmental

The instrument and related documentation must be reviewed for familiarization with safety markings and instructions before operating the instrument. The Quantifit2 is for use at an altitude up to 3,100m (10,170ft.). The operating temperature range is 5 to 40 degrees C, (60 to 104 F) when powered by the external power supply; 5 to 45 degrees C, (60 to 113 F) when powered by the optional battery pack, and 5 to 29 degrees C, (60 to 84 F) when powered by the external power supply with the optional battery pack installed. If the included power supply becomes faulty or damaged, it must be replaced with OHD part number FTK 3010-4021, whose ratings are listed in the [Appendix A: Specifications](#). The QuantiFit2 has an optional removeable/rechargeable battery pack. Only the OHD battery pack part number FTK 3010-4023 may be used with the QuantiFit2. Call OHD (+1.205.980.0180) for information on purchasing replacement power supplies and/or battery packs. The maximum relative humidity is 80% non-condensing and pollution degree 2. If the Quantifit2 is not used specifically in the manner outlined in this manual and for its intended use, the protection of the instrument may become impaired. Under abnormal conditions, such as static discharge, it may be necessary to cycle power to achieve proper operation.

Introduction

Statement on Cross-contamination

The risk of cross contamination resulting from the use of a QuantiFit2 is very minimal. Fit Testing itself **does not** increase or decrease a person's risk of exposure to any virus or illness. The real threat is coming into close contact with an infected person no matter the location or activity.

The QuantiFit2 does not trap air in its system either before, during, or after a fit test. The QuantiFit2 does not push air into the mask. The QuantiFit2 pulls air away from the test subjects' respirator and vents it out of the system. This means that the chances of contaminated air being in the system are, at worst, no more likely than contaminated air being in the surrounding environment. If an infected person were to be fit tested, there is no more risk of contaminated air being trapped and subsequently released on a succeeding fit test than there is just by walking into the fit test area.

The QuantiFit2 and accessories are subject to surface contamination like any item in the test area. Before and after fit test steps, when the test subject is wearing a respirator, his or her inhalation is coming through inlets in the OHD adapter kit, and most of the exhalation should travel through the exhalation valve and out of the respirator. There are many potential respirator and adapter configurations. The chance could exist in a configuration that exhaled breath could contact internal areas of an adapter kit. If it is suspected this has happened, disinfection would be appropriate.

For protection against the transference of surface contamination, all possibly contaminated surfaces the operator or subjects may contact need to be disinfected. This includes the QuantiFit2 and accessories. The adapter kits may be cleaned either by immersion, spray, or wipe from an EPA approved disinfectant as these have been shown to efficiently inactivate over 99% of microorganisms (to include COVID-19) within a minute. The adapter should be dry before use in a fit test. The QuantiFit2 tubing should be carefully wiped down with an EPA approved disinfectant.

If there is a threat of contamination, the fit test operator should take precaution when carrying out fit testing according to the guidance provided by the CDC.

If respirators are shared for fit testing, the fit test operator should follow *OSHA 1910.134 Appendix B-2 Respirator Cleaning Procedures* or the manufacturer's guidelines for the disinfection of the respirator to avoid any cross contamination.

See [Appendix D: CNP Diagram](#) for an air-flow diagram with Controlled Negative Pressure and the QuantiFit2 system.

How the QuantiFit2 Works

The QuantiFit2 functions by creating and maintaining a negative pressure in the respirator. Once the adapter valve is closed, sealing the respirator, the QuantiFit2 removes air from the respirator until the challenge pressure is reached.

When the challenge pressure is reached, if there isn't a leak, the QuantiFit2 doesn't remove any more air from the respirator. If there is a leak, air enters the respirator. The QuantiFit2 then removes air from the respirator until the challenge pressure returns to the targeted value. This process continues for 8 seconds, and then the test step ends.

During the fit test, the QuantiFit2 measures exactly how much air the instrument removed from the respirator after reaching the challenge pressure. This measurement is equivalent to the leak rate.

Challenge pressure, expressed in inches of water, is the maximum partial vacuum created in a correctly fitting respirator when the user is working at a moderate to high rate. The modeled breathing rate is the calculated total inspiration for one minute.

The modeled breathing rate is expressed in liters per minute (LPM), and is multiplied by 1,000 to provide cc/min, it is then divided by the leak rate in cc/min. This is the fit factor ratio. It is a ratio of the total inhalation pressure to the air that leaked into the respirator.

Fit Factor Explanation

The ratio of the modeled breathing rate to the measured leak rate is the calculated fit factor and is expressed by the following equation:

$$\text{Fit Factor} = \frac{\text{Modeled Breathing Rate (cc/min)}}{\text{Measured Leak Rate (cc/min)}}$$

The modeled breathing rate (MBR) is the rate at which an individual could be expected to breathe under moderate to heavy working conditions. The MBR is predetermined for the standard respirator types. The MBR is calculated from the parameters specified by the operator for custom respirators.

The measured leak rate (MLR) is directly related to respirator fit and integrity. All fit factors are calculated from the MLR. The QuantiFit2 directly measures air leakage in cubic centimeters per minute (cc/min) and then calculates the fit factor (FF).

The overall fit factor is calculated by using the harmonic mean of the fit testing steps as follows:

$$\text{Overall Fit Factor} = \frac{N}{[1/FF1 + 1/FF2 + \dots 1/FFN]}$$

Where:

N = The number of exercises;

FF1 = The fit factor for the first exercise;

FF2 = The fit factor for the second exercise;

and *FFN* = The fit factor for the *n*th exercise

Instrument Setup

What comes with the QuantiFit2?

- The QuantiFit2 Respirator Fit Tester
- Triple tube set
- Power supply and power cord
- USB cable
- Hard case with extendable handle and wheels
- Logic software
- Calibration Certificate

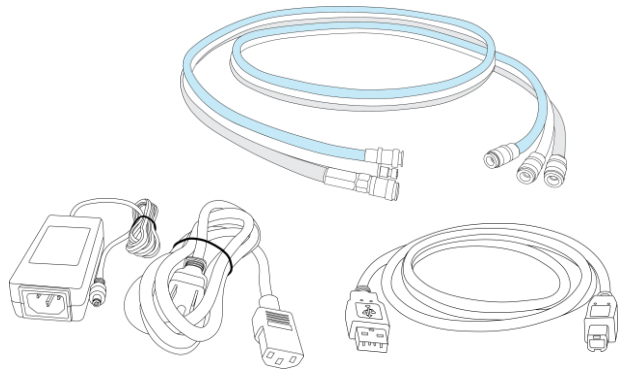

Unpacking the QuantiFit2 Carrying Case:

Release the two latches on the front of the case by depressing the moveable lever under each latch.

- A.** Power cord
- B.** Batteries (optional)
- C.** Adapters (optional)
- D.** Power Supply
- E.** USB Cable
- F.** Tube Assembly
- G.** Additional Storage

Available Accessories

- [Respirator adapters](#) (required for fit testing)
- Rechargeable battery pack
- Printer (standard printer and/or cardprinter)
- USB Keyboard
- Trigger button

Startup

- Connect the power supply or insert battery
- Turn on the instrument with the rocker switch on the rear panel
- Follow the startup wizard (during initial setup only)
- Follow instructions for Daily Verification
- Ready to test

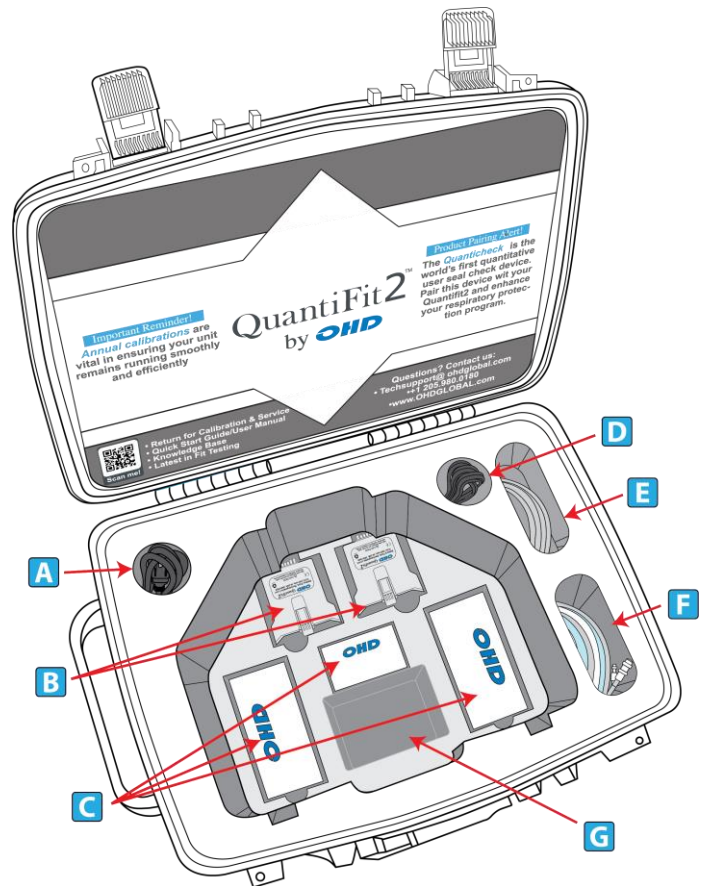

Instrument Setup

Instrument Front Connections

- A. Carrying Handle
- B. Color Touch Screen
- C. Clear Tube Connection
- D. Gray Tube Connection
- E. Blue Tube Connection
- F. Verification Connection for Gray/Clear Tube
- G. Verification Connection for Gray/Clear Tube
- H. Verification Connection for Blue Tube
- I. Daily Verification Connection Points
- J. Instrument Exhaust Port

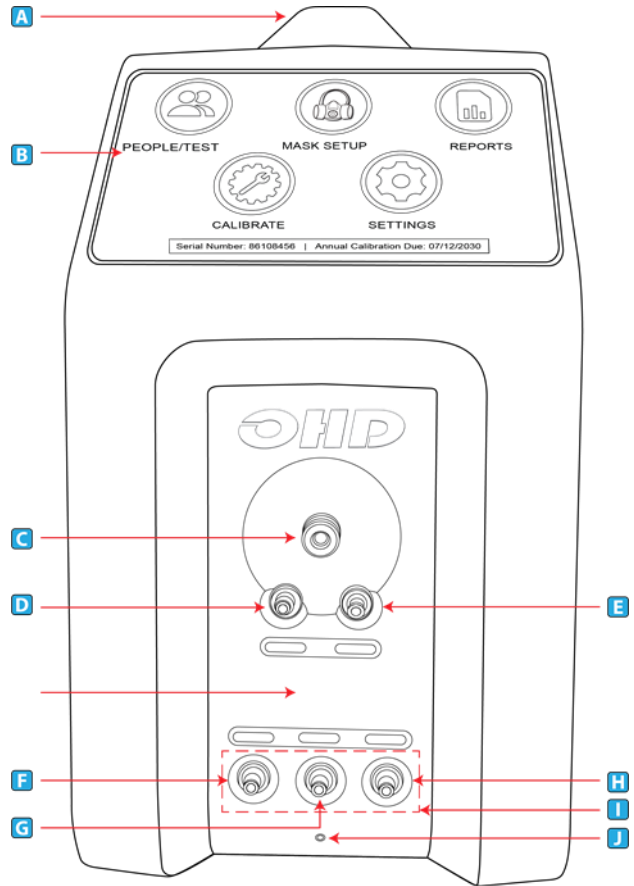

Instrument Setup

Instrument Rear Connections

- A. **On-Off Switch** - The On-Off Switch functions like a standard power switch. Toggle up (|) and the power is turned on. Toggle the switch down (o) and the power is turned off.
- B. **12 VDC, 3A (max) Power Connection** - The power connection is to supply power to the unit, and the universal power supply shipped with the QuantiFit2 must be used.
- C. **Trigger Button Connection** – If the optional Trigger Button is used to initiate test steps, it must be inserted into this port.
- D. **USB Devices (4)** - The four standard USB ports may be used to connect a Keyboard, printer, USB memory stick, or other useful devices.
- E. **USB PC Port** - The USB PC Port is used to connect the QuantiFit2 to a personal computer. The QuantiFit2 is shipped with a supplied cable for this purpose. The USB symbol on the cable must face up to properly insert this cable. This cable allows for the QuantiFit2 to be operated from the supplied software.
- F. **Serial Number** – Located in the center, the serial number is important should you require service or support. All records are kept according to the serial number.
- G. **Battery Latch** – Push down on this latch to release the battery pack and pull outward to remove it.
- H. **Battery Pack (optional) or Cover** – When using an optional battery pack to operate the QuantiFit2, it will be inserted here. When no battery pack is purchased, this cavity will be filled with a blank cover.
- I. **Bluetooth Module** (internal, not shown) - When purchased with the Bluetooth function, the QuantiFit2 can wirelessly connect to a computer with Bluetooth capability.

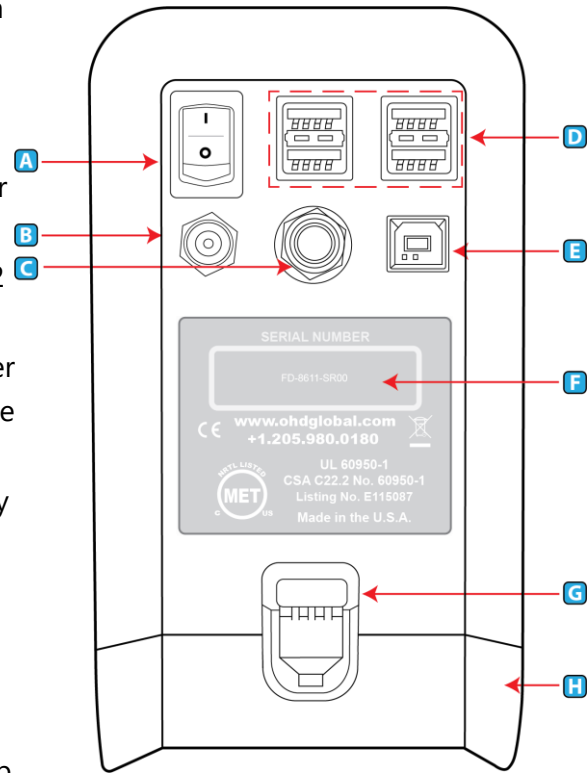

CAUTION: It is vital to open Logic software to pair the device. See [Logic Software section](#).



OHD Logic software allows users to run multiple machines simultaneously, with flexibility on the start time for any test. Standard Bluetooth allows testing to happen from across the room.

Instrument Setup

Connecting Tubes

It is best to connect the metal quick connects while holding onto the tube and not the connection. The metal quick connect will click into place. The tubing set consists of three tubes (blue, gray, and clear). Out of the six ends of the tube assembly, there is only one male connection, which will always go into the large circle on the front of the unit. The other two tubes should be attached to the color-coded ports. When performing a daily verification, the opposite ends of the tubes should be matched with the corresponding colors on the bottom row of the front panel.

On the Adapter

- The blue tube will always connect to the single port connection.
- The gray and clear tubes will be connected to the port connectors that are side-by-side. The two connections are interchangeable on the adapter and can be placed on either port.

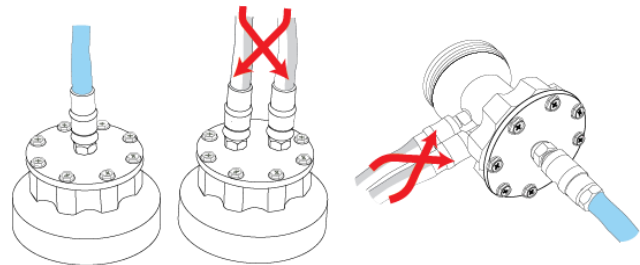

Battery

The optional battery pack can be used in lieu of the power cord. When a battery is in place, if the QuantiFit2 is plugged into a wall outlet and the building loses power, the battery will automatically take over without any interruption to the fit test. The battery may be charged while connected to power whether the QuantiFit2 is in use or not. When fully charged, the battery typically yields approximately four hours of typical testing.

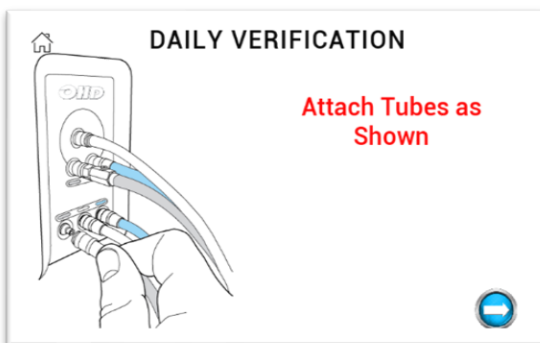
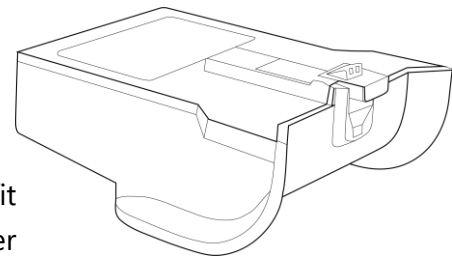

Daily Verification

The daily verification is required for each day of testing. This check measures the leak rate of the leak orifice on the triple tube assembly at various pressure levels and confirms that the diaphragm pump and other processes are working correctly. See the [Daily Verification](#) section for more information.

Startup Wizard

Language

Select your preferred language here.



Regulation

The operator will be required to select the regulation that will be followed for testing in any specific region. This can be changed in the Settings>Admin Menu screen if there is a need to switch regulations. The regulation controls all the test parameters: Select regulation links are listed in [Appendix E: Regulations](#).

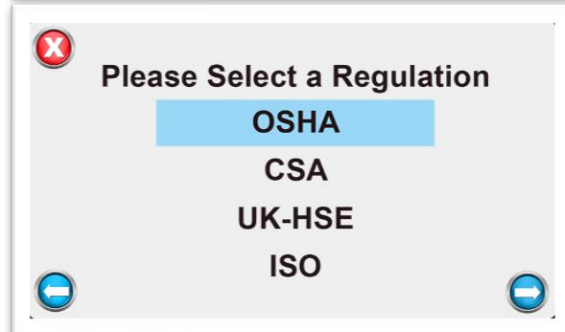

Respirator Selection

Find the respirator(s) that will be used for fit testing and toggle the on/off switch to on. If a particular respirator has not been determined, you may select any respirator and continue. This can be changed later in the Settings>Setup Respirators section.

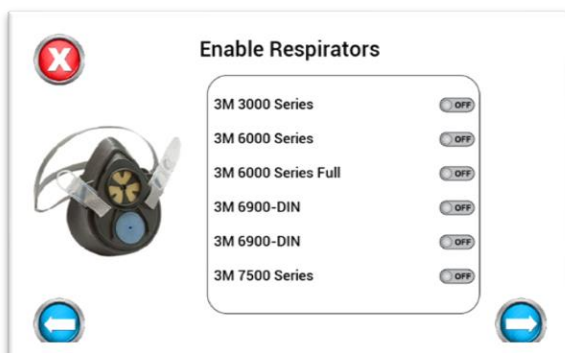

Operators

For every test performed on the QuantiFit2, an operator must be assigned to the record. The Operator screen is used to add/edit operators in the database. Enter one or more operator. Additional operators may be added in the Settings>Admin Menu section. See [Setup Operators](#) for more information.



Startup Wizard

Daily Verification Wizard

This section will guide the operator through a daily verification. This must be performed every day of testing. Upon starting the instrument each day, the Daily Verification screen will appear. See the [Daily Verification](#) of this manual for more information.



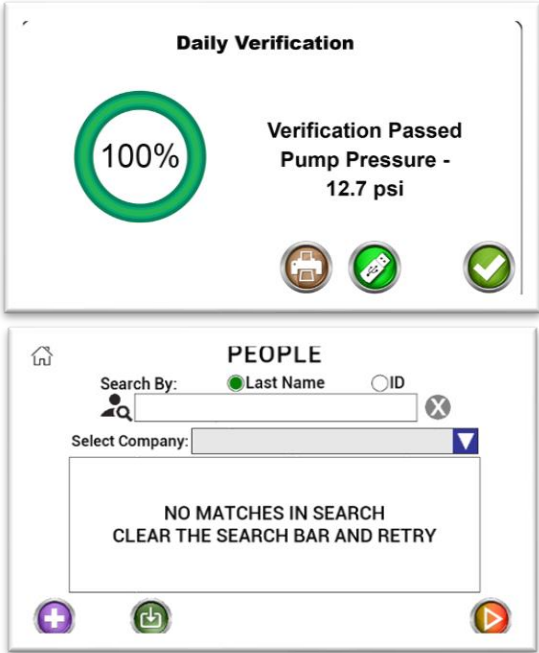

People/Test

After the daily verification check has been performed, the wizard will move on to the People screen. People can be added one by one, imported from a list, or added at the time of a test. The people screen is the last screen in the setup wizard. The operator may close this window or perform fit tests. See [Performing a Test](#) instructions in this manual.









Navigation

The QuantiFit2 is operated by the color touch on the front of the instrument. When pressing any button, there will be a "click-tone". The volume of this tone can be changed in the System Settings menu. There are five major modules to select from:

-  **People/Test:** Where people are added, edited, or imported, and where tests are initiated.
-  **Seal Check:** Holding this button will close off the air flow in the respirator so that the test subject can do a user seal check.
-  **Reports:** Reports that can be printed out or exported one at a time, or by date, company, or group.
-  **Daily Verification:** Used to perform the daily verification requirement for each day of operation.
-  **Settings:** Contains parameters that can be changed for the convenience or requirement of the operator.

Other buttons you will see are:

-  **ADD** – This button will allow the user to add to the records currently viewed, e.g., person, respirator, etc.
-  **ADMIN MENU** - Entry to a menu for secure and important settings
-  **CANCEL** – This button will close the current screen. Any values entered by the operator on the screen will not be saved.
-  **COMPANY** – A separation of people into different groups, teams, companies, etc.
-  **DAILY VERIFICATION** – Will allow the user to perform a daily verification when the initial daily calibration has already been completed
-  **DELETE** – Removes an item from a list

Navigation



DOWNLOAD – For loading people into the QuantiFit2 from the OHD Logic software



EDIT – Allows the operator to change information for the selected item



GO BACK – The back button will allow the operator to return to the previous screen



GO DOWN – To move down through a list



GO FORWARD – This button will guide the operator to the next screen in the sequence



GO UP – This button will guide the operator to move up in a list



NEXT – Takes the operator from the People screen to the test screen



HELP – Dynamic help according to the screen being viewed



HISTORY – Will allow the operator to see recorded information regarding the selected person



HOME - Will bring the operator back to the Home screen



OPERATORS - Add/edit operators that will be testing individuals



PEOPLE/TEST – Add/edit people and initiate fit test

Navigation



PRINT – The print button allows the user to print a report related to the current screen



REPORTS – Brings the operator to a section enabling them to print reports by date or company



RETRY – When a test step is interrupted, this allows the test subject to retry that step



SAVE – The green checkmark will save the information entered on the screen



SEAL CHECK – Allows the test subject to perform a user seal check



SEARCH – A field available on the People screen that allows a search to find the desired test subject quickly and easily



SETTINGS – Enters the screen with options for changing settings on the QuantiFit2



SETUP RESPIRATORS – Add, edit, or delete respirators



SYSTEM INFORMATION – with information including software version, serial number, calibration due date, etc.



UPDATE SOFTWARE – Used when an update is available and saved on a USB drive



USB SAVE – Save report or information to a USB drive plugged into the QuantiFit2

Navigation

People

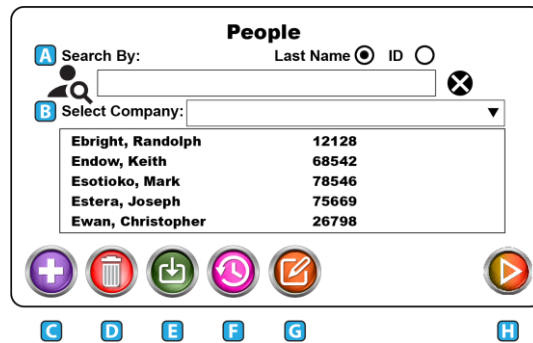

A. Search

Test subjects may be searched by last name or by their personal ID. Click the button to be used for the search. The search will be defaulted to Last Name. Press the X at the end of the search bar to reset all search criteria. Partial names and numbers may be used in the search.

For example:

- o Enter an "E" in the search, and all those in the database with the last name starting with "E" will be displayed.
- o When specifying a company and typing in an E, only those names starting with E and within the company selection will be shown.

B. Select Company

Company is intended to create a division among the test subjects who are entered into the onboard database. To add a company to the QuantiFit2 database, type in a company name when adding a test subject to the database. The company will be saved automatically along with the test record.

CAUTION: When entering the name of a company, it is critical that it exactly matches the previous entries, or a new company will be created.



C. Add

The Add button will open a screen that will require test subject information. The fields available are Name, ID, Company, Group, and Notes.

The 'Add Person' form contains the following fields:

- Name: First, MI, Last
- ID: [Text field]
- Company: [Text field]
- Note: [Text field]
- Buttons: X (cancel), checkmark (confirm)

D. Delete

When a test subject is selected, press on this icon to delete this person from the instrument. There will be a prompt asking if you are sure that you

Navigation

want to delete this person from the database.

CAUTION: After deletion, a test subject cannot be restored.



E. Download

The download feature allows test subjects to be uploaded in bulk. This can be done through a CSV file from the OHD Logic software. See [Appendix B: Import Personnel Template](#) for import requirements.

F. History

When a test subject is selected and the history button is pressed, a screen will show any existing tests for this person. Tests will be listed by date.

G. Edit

When selecting a test subject and pressing on the edit button, there will be an opportunity to change the saved information for this person. This includes Name, ID, Company, and Notes.

H. Next

When a test subject is selected, the Next button will move to the test screen

Performing a Test

Test Screen

The test screen prompts the operator or test subject to select or fill in the details of the test. This includes Respirator, Size, and Operator. The Respirator selection will only show the respirators that have been selected during the setup wizard or in the [Setup Respirators](#) module on the settings screen.

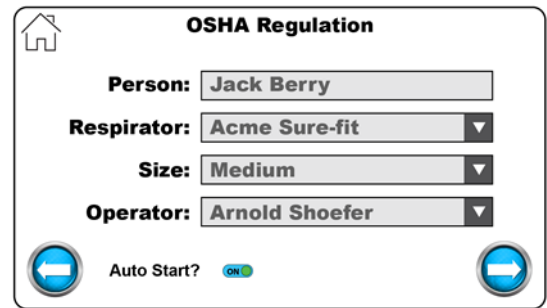

Auto Start

The Auto Start feature is turned on by default. With this on, the test subject takes a comfortable breath preparing to hold it once the circle in the lower right corner fills with green. The QuantiFit2 senses the breath hold and the test automatically begins.

Operator Signature

After the details of the test have been confirmed, the operator can progress to input their signature on screen, if desired. This feature can be turned off in Settings>System Settings>Signature Capture.

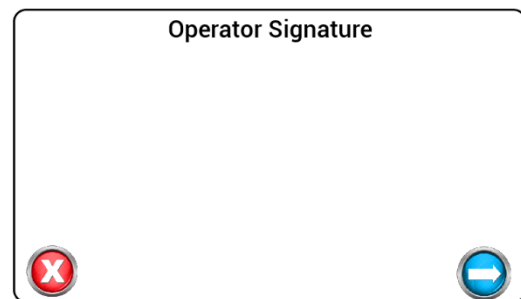

Preparing the Respirator

If the respirator has an inhalation valve at the place where a fit test adapter will be connected to the respirator, it must be removed or propped open.

When the test subject is ready, connect the tube assembly to the adapter(s).

- The blue tube goes to the single port.
- The gray and clear tubes go to the two ports that are located side by side. It does not matter which tube is connected to which of these two connectors. See [Appendix F: Fit Test Adapters](#) for more information.

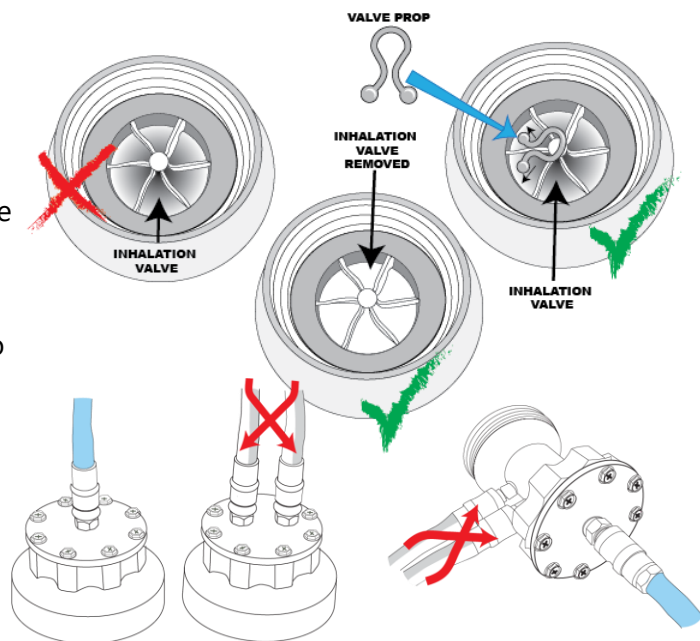

Beginning a Fit Test

After selecting or adding a person to the database, the test can begin. Explain the test to the test subject: During each step, the test subject will be given instructions to be in a specific position for the test, and a possible action to perform before the test step begins.

Performing a Test

Initiating the test step:

With Auto Start

- If the Auto Start feature is turned on: Instruct the test subject to take a comfortable breath preparing to hold it once the circle in the lower right corner fills with green.
 - The test will begin automatically.
 - Remain still for the duration of the test
 - Pressing the green button will also initiate the test.

Without Auto Start

- If not using Auto Start, instruct the test subject to take a comfortable breath preparing to hold it once the circle in the lower right corner fills with green, and then press the green button on the screen.

At the end of each step, a fit factor will show for several seconds. If the fit factor is greater than the minimum fit factor required, the instrument will advance to the next step. If the test should fail for reasons other than a poor fit (test subject coughs, the test starts when the test subject was not ready, etc.), the step may be retried.

After the final step, if the signature feature is enabled, the test subject will sign on the touchscreen.



At the end of the test, the results are saved into the database and cannot be edited. The operator may choose to print the test results immediately or wait to print later. The test is stored and able to be accessed at any time.

Reports



Reports may be printed at the time of the test, or any time after the testing has been completed. The following reports are available on the QuantiFit2:

Fit Test Reports

- Individual

A single-page report that contains all required data for a respirator fit test record. This report includes a fit test card at the bottom of the sheet for the test subject to keep.

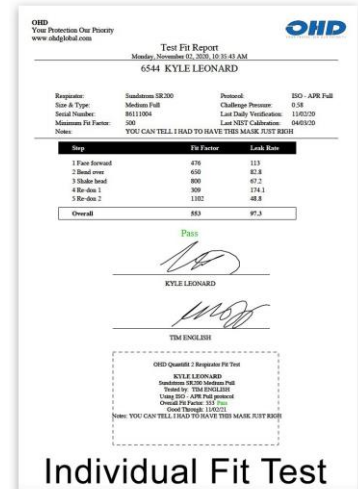

Individual Fit Test

Fit Test Reports

Company:

Person:

Date Range: to

<u>Report Type</u>	<u>Format</u>	<u>Output</u>
<input type="radio"/> Individual	<input type="radio"/> PDF	<input type="radio"/> USB
<input type="radio"/> Summary	<input type="radio"/> CSV	<input type="radio"/> Print
	<input type="radio"/> Both	

- Summary

A report that will print the specified group of people in a truncated fashion, which allows for many people to be recorded on the same sheet.

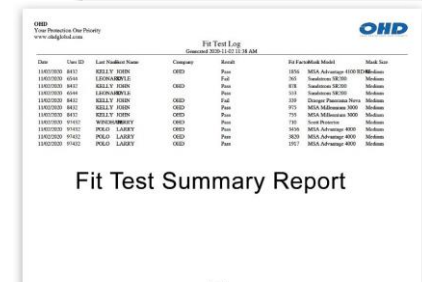

Fit Test Summary Report

Fit test reports can be selected by:

- Company
- An individual person
- Tests that fall within a specific date range



Verification Report

Verification Reports

Quick selections include:

- Today
- Current week
- Previous week
- Current month
- Previous month
- Custom [Date Range]

Verification Reports

Date Range: to

<input type="radio"/> Today	<input type="radio"/> PDF	<input type="radio"/> USB
<input type="radio"/> Current Week	<input type="radio"/> CSV	<input type="radio"/> Print
<input type="radio"/> Last Week	<input type="radio"/> Both	
<input type="radio"/> Current Month		
<input type="radio"/> Last Month		
<input type="radio"/> Custom		

Print/Export Reports

The reports can be saved as a PDF file, CSV file, or both, or printed directly to an approved printer.

Daily Verification



The daily verification is required for each day of testing.

When turning on the instrument for the first time each day, the Operator will first be prompted with the daily verification message. Once the daily verification has been performed for the day, this message will no longer appear when the unit cycles power.

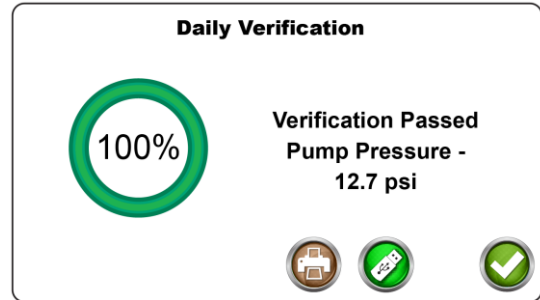

The daily verification measures the leak rate of the leak orifice on the triple tube assembly at various pressure levels and flow rates and confirms that the diaphragm pump and other processes are working correctly.

The daily verification may be performed at other times for other purposes. A Daily Verification button can be found on the QuantiFit2 Home Screen.

Run a daily verification when:

- The instrument moves to another location, especially with any environmental changes.
- Whenever the triple tube assembly is changed.

Troubleshooting:

If the instrument does not pass the daily verification, troubleshooting information will be displayed. If the verification will not pass after troubleshooting steps, the unit may require service. Contact OHD technical support (techsupport@ohdglobal.com).

Onboard Settings



System settings

Cylinder Test Mode is used for demonstration purposed or validation testing.

Volume allows the operator to increase or decrease the volume of the audio indicators that one might hear when testing or entering test data. The settings are 0 to 10, where 10 is the loudest.

Brightness allows the operator to increase or decrease the brightness of the display. The settings are 1 to 10, where 10 is the brightest.

Auto Print is turned on when the operator desires the test automatically to be printed upon completion of a fit test.

Number of Prints allows the operator to select the number of prints when printing reports. To be used when more than one copy is required.

Auto Advance will automatically advance to the next step after a step has passed successfully. If the test step fails, the operator will be given the option to retry the step or advance to the next step. The auto advance feature may be turned off, and the operator must then select the arrow button for the next step, or the retry button when a retry is necessary.

Auto Advance Time allows the operator to set the time given before the test step advances to the next step when the auto advance function is turned on.

Redon Delay is the number of seconds to delay the QuantiFit2 while the test subject redonsthe respirator so that auto start is not analyzing samples while the redon is taking place.

Signature Capture allows the operator to turn off the signature capture at the end of each test if the signatures are not necessary or required.

System Information

The information button will display helpful information when contacting OHD for support including:

- **System Version** – The current version of on-board software
- **Cycle Count** – The number of cycles the instrument has run
- **Calibration Due Date** – The date due for annual calibration requirements
- **Current Date** – Can be changed by touching the current value

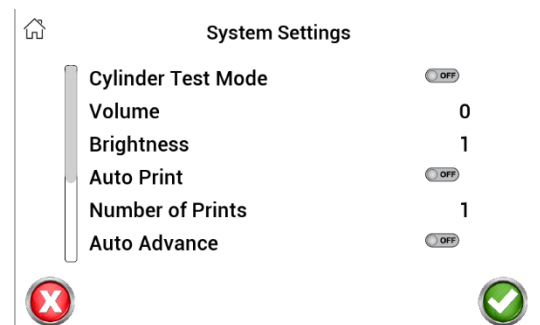
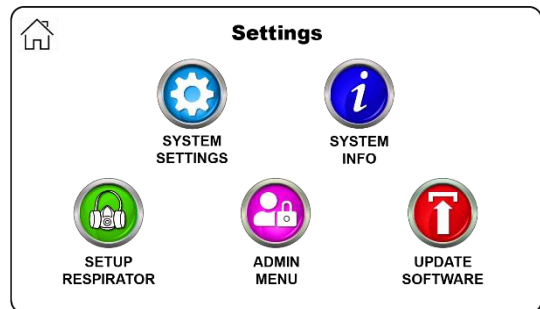

Onboard Settings

- **Current Time** – Can be changed by touching the current value



Setup Respirators

The QuantiFit2 is populated with an extensive list of respirators. When selecting respirators, only those turned "on" will be available as a selection on the Test Information screen during a fit test.

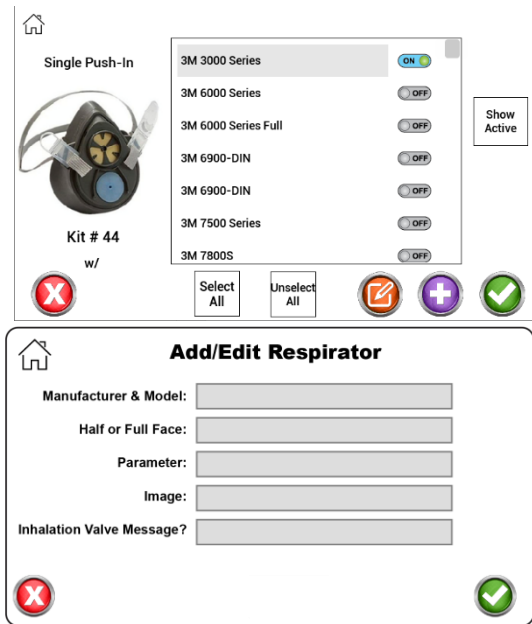

If the respirator that is being tested does not appear on this list, a new respirator may be added to the list. The following fields will be required:

- Respirator Manufacturer and Model
- Half or full face
- Parameter
- Image
 - An image can be uploaded into the database from a thumb drive.
 - The respirator image should be no larger than 240 pixels wide by 370 pixels tall.
 - The respirator image should be a *.png file.
 - When no image is uploaded, "No Image Available" will be shown in place of the image.
- Inhalation Valve Message:
 - Turn off the message about the inhalation valve if this respirator does not have an inhalation valve that interferes with the test.



Admin Menu

The Admin Menu is a directory for critical settings. These settings should be changed only by a person who has been trained and understands the purpose of each setting.

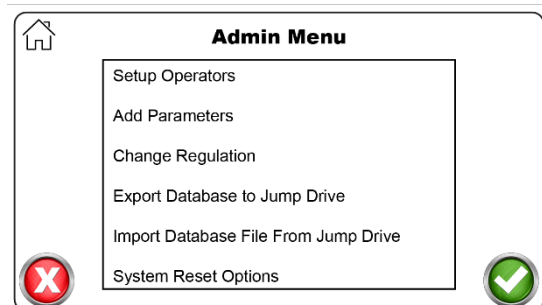

Setup Operators

Operator setup is necessary to record those people who will be running the tests. To record an Operator, there are key fields required:

- First and Last Name
- Email

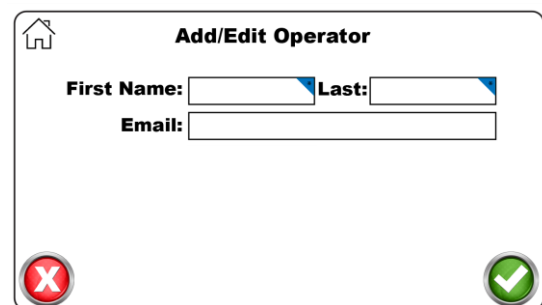

Onboard Settings

Add Parameter

The Add Parameter function will allow an operator to customize options for a particular respirator if the desire is to test outside of the standard testing parameters. You will need to enter:

- Parameter name
- Challenge Pressure: The negative pressure rate at which a respirator is tested
 - 0.58 in H₂O is used in the APR parameters
 - 1.0 in H₂O is used for CBRN and military function
 - 1.5 in H₂O is used for SCBA respirators
- Modeled Breathing Rate: The breath that is emulated during the fit test
 - 53.8 L/min is used for APR settings
 - 55.8 L/min is used for CBRN and military function
 - 93.1 L/min is used for SCBA respirators
- Passing fit factor: The minimum fit factor required to pass a test step and overall fit factor.

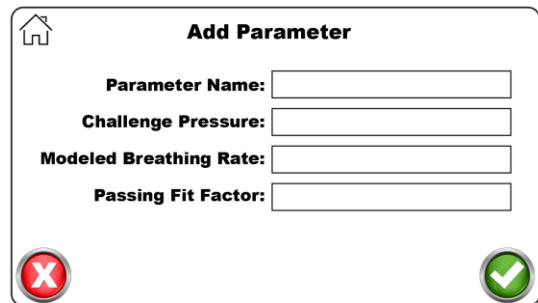

Add Parameter

Parameter Name:

Challenge Pressure:

Modeled Breathing Rate:

Passing Fit Factor:

Change Regulation

The QuantiFit2 is designed so that when a regulation is selected, all tests are automatically executed with the correct settings. New regulations will be added in future updates as they become available or are modified. Links to select regulations are listed in [Appendix E: Regulations](#).

Export Database to USB Drive

Allows users to create and save a complete backup of the onboard database including people, fit tests, operators, selected respirators, and various other settings.

Import Database File From USB Drive

This is how you restore a backup database and can also be used to share databases across multiple units.

System Reset Options

There are numerous reset options according to which information needs to be reset:

- Clear People List will remove all the people in the current database.
- Clear Test Records will keep the people list but will delete all test information.
- Clear Operators will remove all operators listed in the unit.
- Clear Custom Parameters will remove any parameters that have been manually added to the database.
- Restore System Defaults will change all operational settings to the settings that were

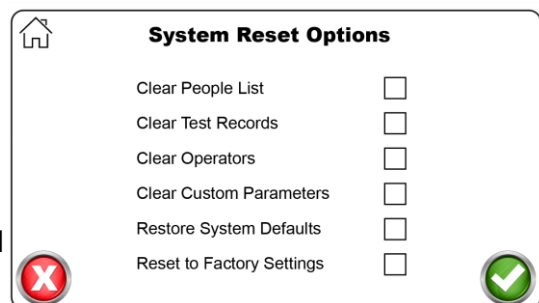

System Reset Options

Clear People List

Clear Test Records

Clear Operators

Clear Custom Parameters

Restore System Defaults

Reset to Factory Settings

Onboard Settings

originally implemented on the instrument. This option will not erase any of the information listed above.

- Reset to Factory Settings will remove all data on the Quantifit2 and it will operate as though it is the very first time the unit is powered up.

Company Info for Reports is a customizable header that will appear on reports printed directly from the QuantiFit2

Run Battery Drain Procedure

CAUTION: Must be performed to prepare battery for shipping. Please remember this as you prepare to ship your instrument back for annual calibration.



Language Change selected language



Update Software

Occasionally there will be updates to the on-board software. OHD will notify customers when an update is available if the unit has been registered. The notification will come via email. The update can be downloaded from a website and saved to a USB Drive. With the USB Drive in any port on the back of the instrument, the Update Software button will ask the operator to select the update file. After the update, the instrument will automatically cycle power at the appropriate time, reboot the system, and be ready for testing.

Logic

OHD Logic Software is intended to be driven by icons, and each icon function can be viewed by mousing-over the icon. In the case of the icons on the left sidebar, the Menu icon at top left can be clicked, and the menu will pop-out to display the names next to each icon.

As with most programs, there are many ways to do the same task, and different operators may feel more comfortable doing things one way as opposed to other ways. These instructions will cover the different ways to do each item or task.

If there are uncertainties about any part of the software, check the corresponding section in this manual or in the software.

Our goal is to make this software as intuitive as possible. We always welcome feedback.

OHD Logic

OHD Logic Software is to be installed on a PC running Windows software version 10 or greater.
PC requirements:

- Processor Speed: 1.0 GHz or greater
- RAM: 1 GB or greater
- Disc Space: 16 GB

The installation must be completed by someone logged onto the PC who has administrative privileges.

The installation file will install all prerequisite files including Windows requirements.

1. You may have to approve the installation of this file as it might be one that Windows doesn't recognize, or if you downloaded it from our website.
2. You may be prompted to install .Net Core Runtime 3.1.1 This file is required to run Logic. Click Yes to continue the installation, which will take you to the Microsoft dotnet website. Click on the x64 version and follow the install prompts.
3. Follow the install wizard and launch the program

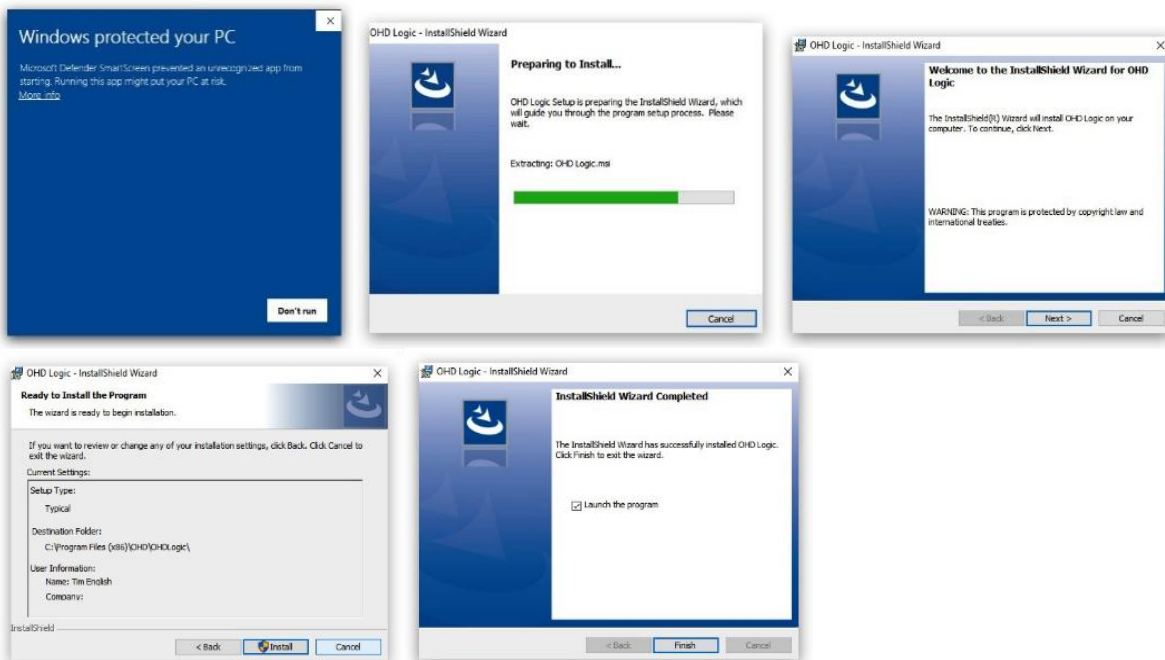

Software Updates

OHD Logic software will be updated periodically to enhance features, add features, or fix bugs. In the [Settings](#) section, there is an option to automatically receive updates. If this is not turned on, whenever the Update menu is selected, the software will check to see if an update is available and there will be an option to update or not.

Software updates will typically install "on top of" the current installation and an uninstall will not be required. However, if an uninstall is required for any reason, this will not affect the database. It is best practice with any software to back up data when updating or uninstalling a program.

Home Screen

After initial setup, most people can do any task required directly from the Home Screen. This includes running tests, adding people, adding respirators, viewing test statistics, and identifying those people who are due for testing.

Each of the modules seen on the Home Page can be collapsed by clicking on the no-view icon. When doing this, the module will become a button that goes to the right-most edge of the viewing screen. These modules will still be in operation, but they won't clutter the screen if they are not used regularly.

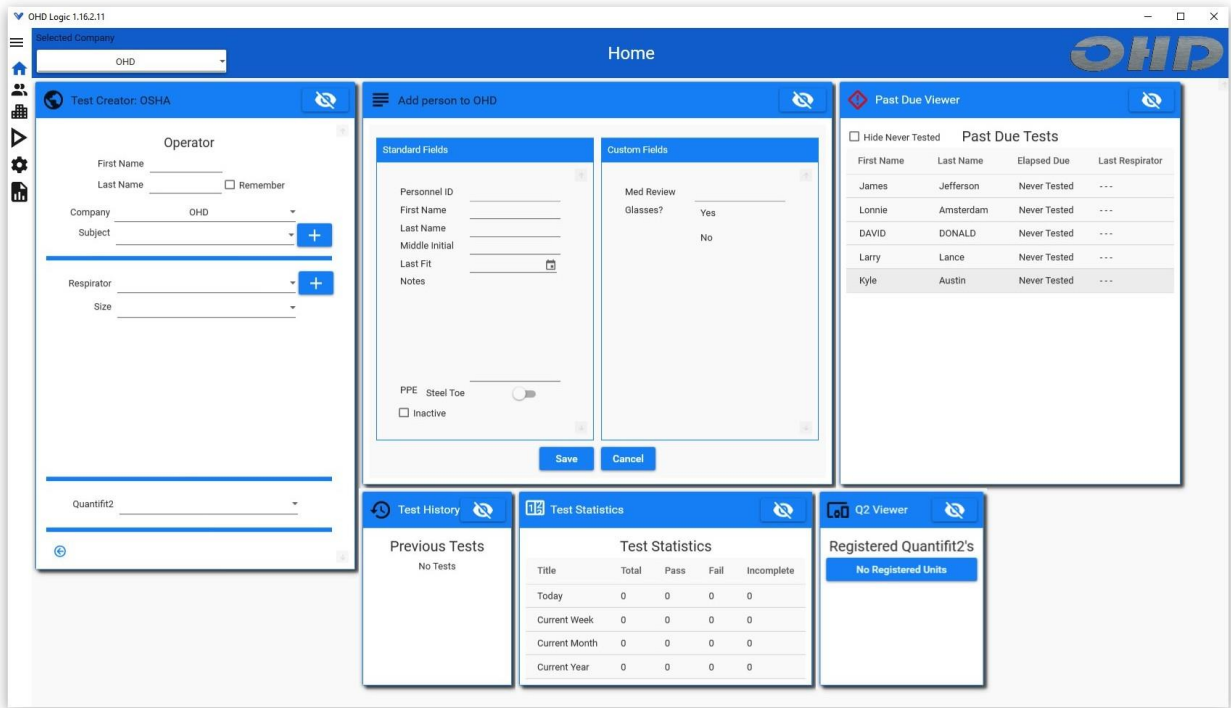

The top bar of the software displays the name of the section (Home Screen), the selected company, and the operator that is currently logged in (when the security feature is enabled). The company can be changed at any time, and if security is activated, the operator can log out of the software

Home Screen

Test Creator

To perform a fit test, it must be launched from the Test Creator. The Test Creator is a simple guide to record pertinent test information and to initiate the test. All fields must be complete for the Start button to appear.

- Operator

Add first name and last name to the operator selection.

Check the "Remember" box if the name is to be remembered throughout the current testing session.

When "Remember" is not checked, an operator's name would need to be input for each test.

- Company

Select the company from which the testing is to be performed. The company can also be selected in the title bar of the Home Screen.

- Subject

Put the computer cursor in this field and begin to type a person's name (first name, last name). There is a lookup that matches names letters are entered.

When the correct person appears in the field, move on to the respirator selection.

A person may also be found by using the field's drop-down arrow and scrolling through the list of names.

If the test subject does not appear in the list of names, click on the "+" symbol to add a person. This will bring up the Add Person screen if that screen is not already opened.

When the information has been added and the Save button is clicked, the added name will appear in the Subject field.

- Respirator

When selecting the Respirator drop-down menu, those respirators that were enabled in the [Respirator](#) section will be visible. A respirator may be added by clicking on the "+" button, which will open the Respirator Management screen. Click on the toggle switch  to add a respirator to the available list.

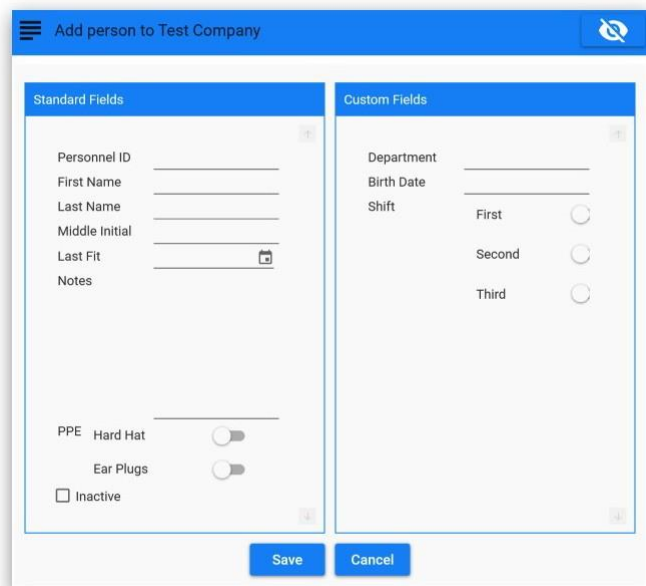
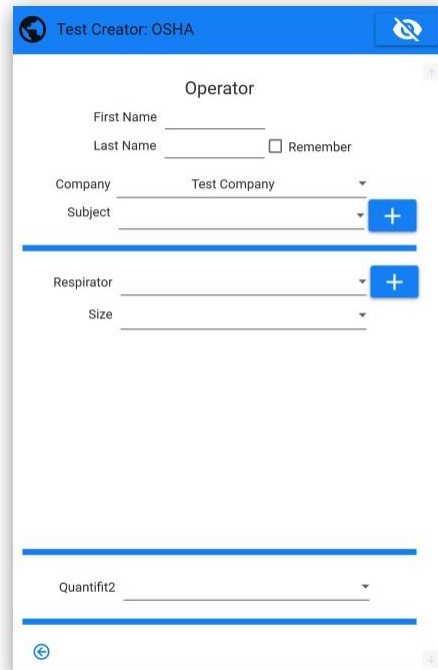

Home Screen

Select a size from the drop-down menu.

- QuantiFit2

Use the drop-down menu to select the instrument you want to use for testing.

If a QuantiFit2 has not been registered to the software, this will need to be done through the Settings/Devices menu.

If only one unit is registered, this field will be populated with that instrument.

If there is more than one instrument registered, this field will remember the last one used.



Add Person

There are various ways to enter people into the software for testing. For larger groups of people, it might be most effective to import a list of people through the Import/Export feature in the Settings/Data section. Another way is through the People section. But people may also be entered in this module on the Home Screen. The name is required, but other fields are optional according to how the data is required by the organization. PPE options are set up under the Company record and will record the PPE assigned to this person.

A screenshot of a software interface titled 'Add person to Test Company'. The form is divided into two columns: 'Standard Fields' and 'Custom Fields'. The 'Standard Fields' column includes input fields for 'Personnel ID', 'First Name', 'Last Name', 'Middle Initial', and 'Last Fit' (with a calendar icon), and a 'Notes' field. Below these are PPE options: 'Hard Hat' and 'Ear Plugs' (both with toggle switches), and an 'Inactive' checkbox. The 'Custom Fields' column includes 'Department', 'Birth Date' (with a calendar icon), and a 'Shift' section with three radio button options: 'First', 'Second', and 'Third'. At the bottom of the form are 'Save' and 'Cancel' buttons.

The optional fields shown in a second column, if they have been modified or changed, are regulated under Company record. Three types of custom fields can be added for record keeping:

- Field - which would have a blank field to be filled in.
- Date - for selections such as birthdate, date of hire, etc.
- List - when predetermined selections are required.
 - The list can be modified at any time. If a field is removed, the data contained in that field will not be deleted and can be seen if that field is activated again.
 - See the list options under the [Company](#) section of this manual.

Home Screen

Past Due Viewer

This tool allows the operator to quickly view those who are due for a test.

The list will show any person in the database who is within a month of needing testing.

By default, the "Hide Never Tested" box is left unchecked.

In addition to those due for testing, the list will also contain those people in the database who have never been tested. The people who have never been tested can be hidden from view when checking this option.

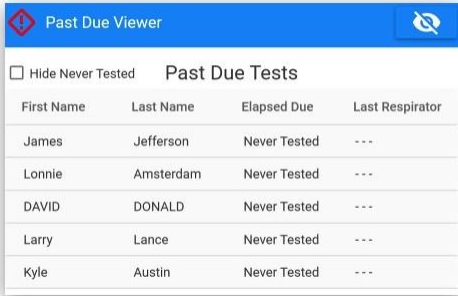

The screenshot shows the 'Past Due Viewer' interface. At the top, there is a blue header with a red warning icon and the text 'Past Due Viewer'. Below the header, there is a checkbox labeled 'Hide Never Tested' which is unchecked. To the right of the checkbox is the title 'Past Due Tests'. Below this is a table with four columns: 'First Name', 'Last Name', 'Elapsed Due', and 'Last Respirator'. The table contains five rows of data.

First Name	Last Name	Elapsed Due	Last Respirator
James	Jefferson	Never Tested	---
Lonnie	Amsterdam	Never Tested	---
DAVID	DONALD	Never Tested	---
Larry	Lance	Never Tested	---
Kyle	Austin	Never Tested	---

Previous Tests

This module will contain a list of tests listed in the order in which they were performed and recorded.

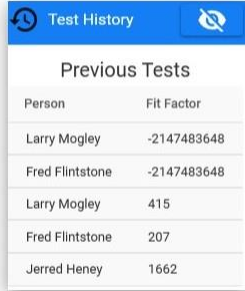

The screenshot shows the 'Previous Tests' interface. At the top, there is a blue header with a clock icon and the text 'Test History'. Below the header is the title 'Previous Tests'. Below the title is a table with two columns: 'Person' and 'Fit Factor'. The table contains six rows of data.

Person	Fit Factor
Larry Mogley	-2147483648
Fred Flintstone	-2147483648
Larry Mogley	415
Fred Flintstone	207
Jerred Heney	1662

Test Statistics

Test Statistics will show a quick snapshot of current testing.

This includes records of tests that are passed, failed or incomplete. Tests will also be categorized between the current week, month, and year.

The current week begins with Sunday and ends with Saturday.

The current month begins with the first day of the month, and the current year begins January 1.



The screenshot shows the 'Test Statistics' interface. At the top, there is a blue header with a bar chart icon and the text 'Test Statistics'. Below the header is the title 'Test Statistics'. Below the title is a table with five columns: 'Title', 'Total', 'Pass', 'Fail', and 'Incomplete'. The table contains four rows of data.

Title	Total	Pass	Fail	Incomplete
Today	0	0	0	0
Current Week	0	0	0	0
Current Month	0	0	0	0
Current Year	13	3	2	8

People

The people list shows the people in the currently selected company who have not been made inactive. The All Companies box can be checked for a list of people throughout all companies.

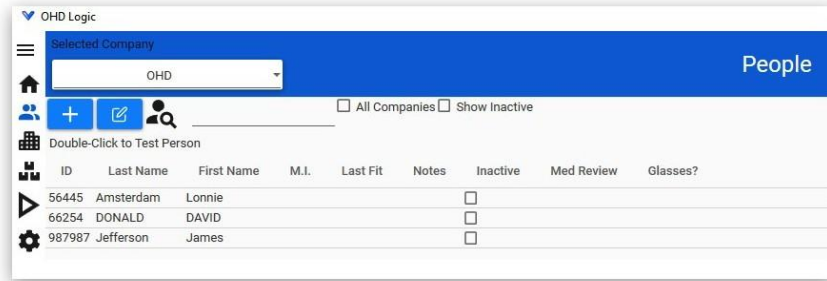

Users can be made inactive if they have left their position, or no longer require fit testing. Their records will not be deleted, but they will be hidden from view. To reactivate a person, click on "Show Inactive," select the person, and click on the Toggle Active button.

People can be added or edited on this screen. The plus sign will bring up an Add People screen, while the edit button will allow the currently selected person's record to be edited. The search field can contain any combination of letters that appear in someone's name, and that person will show up in the list.

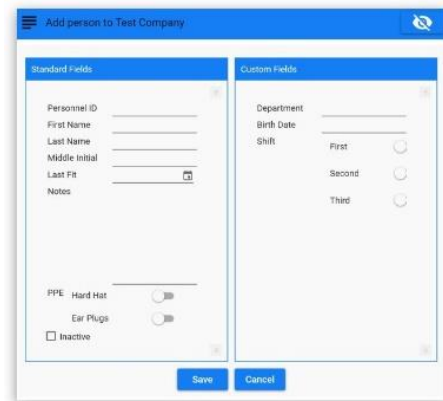

Typing "ian" will bring up anyone named Ian, as well as Brian.

Typing Brian will bring up only those people named Brian.

Typing B will bring up anyone with a "B" as a part of their name.

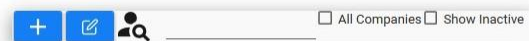

Sync

The Sync function is located on the People Screen.

This will allow you to sync your data from the QuantiFit2 machine to your Logic software. It will also sync whatever you have selected in Logic to your QuantiFit2 machine. If you have filtered a certain company and certain names as shown below, this is what will sync to your QuantiFit2 machine.

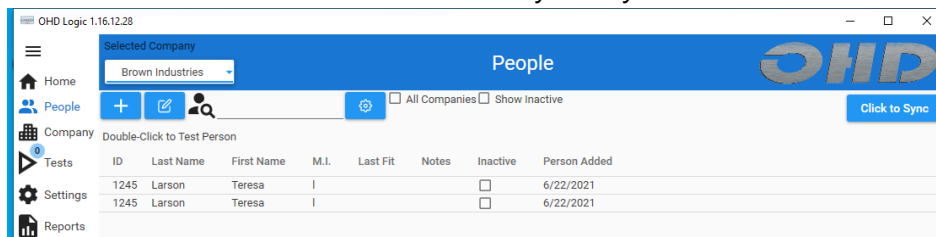
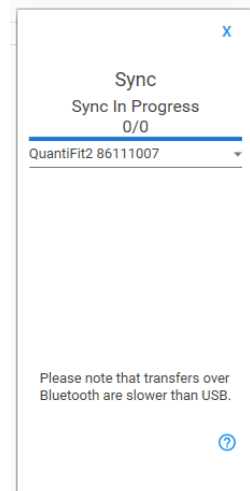

Company

Many QuantiFit2 users will have only one company, while others might have dozens, depending on the needs for testing. The purpose for a Company is to create a division within the database. The company name will appear on the top of the fit test reports. Company divisions are not necessary and are only for convenience. The number of people that can be listed in a company is virtually unlimited. A shared instrument can have a company for each entity that is using the instrument.

A person can be transferred to any existing company.

Add Company Screen

- The required field is the company name, the rest is for record keeping
 - Add PPE that might be assigned to the individual
 - Custom fields include fields, dates, and lists
- A field is an open text box
A date will show a calendar
A list allows the operator to create list items which permit multiple selections

Field Name	Field Type	Required
Department	Field	<input type="checkbox"/>
Birth Date	Date	<input type="checkbox"/>

Configure List

Shift: List Third First Second

+ - Add Remove

Tests

The test screen is where any active test can be viewed. This may be one test, or it may be for an operator who is controlling multiple instruments. The QuantiFit2 allows users to run countless machines simultaneously through the OHD Logic software (as many machines as an operator is capable of overseeing), with flexibility on the start time for any test. This screen also contains a Test Creator to begin new tests while viewing current tests.

Test Creator: OSHA

Operator

First Name: Jack
 Last Name: Cornell Remember

Company: OHD
 Subject: _____

Surrogate?
 Respirator: _____
 Size: _____

Quantifit2: _____

Tests

Jerred Heney APR Half - Test Running

Mask Name: 3M 6000 Series
 CP: 0.58
 Passing FF: 100

Step	FF	Status
Face forward	173	Test Passed
Bend over	187	Test Passed
Shake head	0	Test Running
Re-don 1	0	Waiting
Re-don 2	0	Waiting

Challenge Pressure vs. Percent Complete graph: Shows a pressure curve that rises to a plateau around 0.58 after approximately 10% completion.

Gary Palomino APR Half - Waiting

Mask Name: 3M 6000 Series
 CP: 0.58
 Passing FF: 100

Step	FF	Status
Face forward	0	Waiting
Bend over	0	Waiting
Shake head	0	Waiting
Re-don 1	0	Waiting
Re-don 2	0	Waiting

Challenge Pressure vs. Percent Complete graph: Shows a flat line at 0.58 pressure until 100% completion.

Larry Mogley APR Half - Waiting

Mask Name: 3M 6000 Series
 CP: 0.58
 Passing FF: 100

Step	FF	Status
Face forward	0	Waiting
Bend over	0	Waiting
Shake head	0	Waiting
Re-don 1	0	Waiting
Re-don 2	0	Waiting

Challenge Pressure vs. Percent Complete graph: Shows a flat line at 0.58 pressure until 100% completion.

Tests

The testing sequence

When initiating a test from Logic, the software will display the inhalation valve message reminder, and then display the tube connection instructions. These two screens can be turned off by checking the box next to "Hide these messages next time."

The test subject will view a message that says, "Device is in remote mode. Please wait until the Operator sets up the test."

If the daily verification check has not been completed for the day, the QuantiFit2 will prompt the user to perform this check.

When the test is initiated, the test subject will see "Please review this information. If correct, press the blue arrow to continue." (Name, size respirator, parameter, surrogate).

The next screen will prompt for Operator's signature. Once signed, it will store the Operator's signature indefinitely in Logic software, until Operator is deleted. Test subject will then follow the QuantiFit2 on-screen instructions to complete the test.

If a test step should fail for any reason, the operator will be notified on the software test screen and be given an option to retry the step or save it (if a fit factor was calculated).

There are some troubleshooting suggestions that can be seen by clicking on the question mark in the upper left of the test screen next to the Delete button. See the [Troubleshooting](#) section for more information.

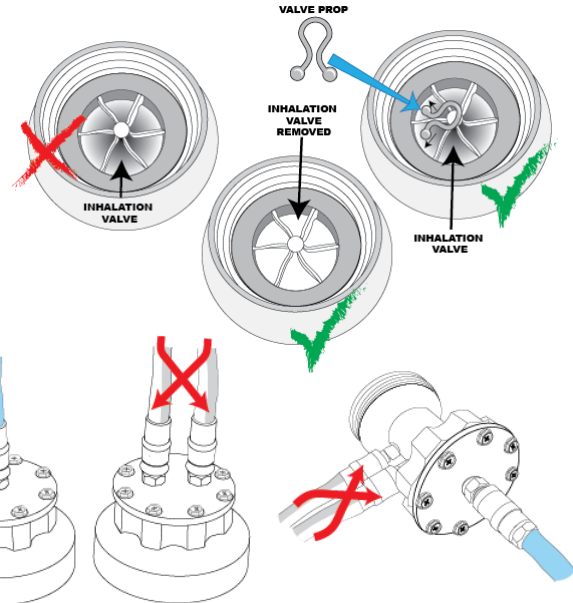

Software Settings

Security

The security mode is turned off by default but can be enabled at any time. Click on the check box, and a message will appear to make sure it is intentional that the security function is being turned on.

If the Security feature was used in this database at any time in the past, then Administrator(s) will already exist. If this is the case, make sure the administrator credentials have been recorded and are accessible. If no Administrator was ever created, the operator will be given an option to create a login.

After the login is created, the user immediately will be required to log in to use the software.

Once Security is turned on, and an Administrator is logged in, the Administrator can then add other Operators and/or Administrators.

Administrator vs. Operator

When Security is activated, to gain access to the software, a person will need login credentials. These credentials either will be assigned to Operator or Administrator status.

- Operator status allows a person to log into OHD Logic and run tests, reports, add people and all the regular functions of a fit testing program.
- Administrators are unique from Operators in that Administrators can gain access to all the setup items.

If the password is lost or forgotten and nobody can gain access to the software or to the Settings functions, OHD must be contacted, +1-205-980-0180, option 4, or techsupport@ohdglobal.com.

The person requesting login information must be able to prove that they have authority to control the software (as determined by OHD's tech support team). OHD claims no liability as to the privacy of a customer's data.

Software Settings

Options

The options section offers flexibility as to how the software operates.

- **Default View** allows the Administrator to select which main screen should be shown when the software is launched.
- **Base Theme** allows the Administrator to change the software view to light mode or dark mode.
- **Select Regulations** allows the operator to choose a testing regulation other than the one that was selected upon initial setup.
- **Allow Auto Updates** will cause the software to check for updates each time the software is opened .
- **Login Timeout** is defaulted to Off. By selecting a time increment, this will determine how long the software can remain untouched before it automatically logs the Operator or Administrator out.
- **Date Format** allows the Administrator to select the type of date format preferred. (MM/DD/YYYY, DD/MM/YYYY, YYYY/MM/DD)
- **Allow Reporting** When this feature is allowed, the software will send errors to OHD. This will help OHD to continue to refine the software, and it may help with troubleshooting issues.
- **Valve Prop Messages** will universally turn the valve prop message on or off regardless of respirator being used.
- **Default Auto Start** Each time a test starts, it will always default to using the auto start feature unless this option is not turned on. If the feature is not turned on, it will remember the last used setting.
- **Save Changes** to make sure that any changes will take effect.
- **Export** will allow the Administrator to export these default settings and import them into another database on another PC.
- **Restore Defaults** will change the above settings to the way that they were upon the initial install of OHD Logic.



Devices

Connecting the Quantifit2 to Logic

Under the settings section, click on Devices. You can connect via USB or Bluetooth. Once your serial number appears below this button, click on Register button, then it will appear on the right as shown below. To test connection, highlight your serial number and click the Test connection button to confirm.

When connecting via Bluetooth, make sure to pair the device by opening Logic software and going through the steps above to register your device.

The screenshot displays the 'Devices' section of the Logic software interface. On the left is a vertical navigation menu with options: Devices, Security, Options, Respirators, Data, Update, and About. The main area is split into two panels:

- Register New Quantifit2's:** Contains a 'Find Quantifit2's' button, a 'Stop' button, and a 'Register' button at the bottom.
- Previously Registered Devices:** Contains a 'Test Connection' button, a 'Remove Device' button, and a 'Restart Unit' button. Below these is a table with the following data:

Name	Serial	Last Used	Last Calibration	Last Daily
Quantifit2 86111007	1007	1/1/0001	4/20/2021	6/8/2021

Additional controls in the 'Previously Registered Devices' panel include a 'Rename' button and a text input field labeled 'Rename'.

Respirators

Respirator List

OHD Logic Software comes with a pre-populated list of respirators. Every effort is made to keep this respirator list up to date, but if a respirator that is being used does not appear on the list, it may be added. OHD would like to be notified if a respirator is not listed (techsupport@ohdglobal.com) so that we may update our list, which will be distributed to our customers as updates are completed.

Find the respirator manufacturer and model that will be used for testing and turn that selection on with the toggle switch.

When a respirator is turned on, it will become part of the selectable respirator list when performing a fit test. When respirators are no longer being used, the respirator may be "turned off." This will in no way affect previous tests that have used this respirator.

To create a new respirator:

- Click on the New button.
- Type in the Manufacturer and Model Name.
- Select Type of respirator (APR-Half, APR-Full, PAPR, Gas respirator, and SCBA). Each respirator will have different testing parameters according to which regulation has been selected for your testing.

An image may be uploaded so that the respirator can be seen when selected. The image target size ideally should be 240 X 370 pixels, or it will be sized when importing.

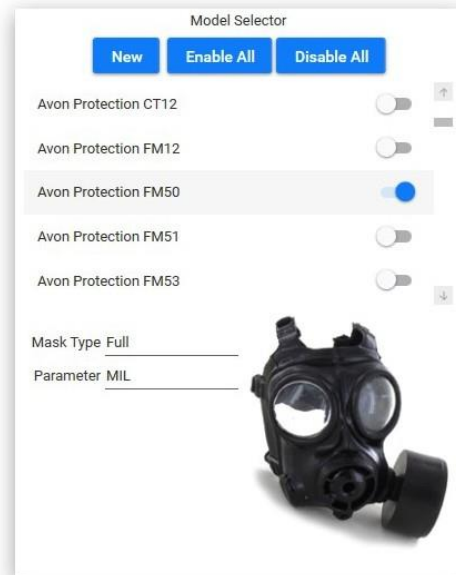

Respirator Sizes

The default respirator sizes that are pre-programmed into the software include: Small, Medium, Medium-Large, and X-Large.

The respirator sizes module allows the operator to add additional respirators sizes if the need should arise. This could include sizes such as One-Size-Fits-All, X-Small, etc. The operator may also delete sizes of respirators that are not a size used by a specific respirator manufacturer. This would prohibit operators from selecting the wrong size by mistake.



Respirators

Parameters

Parameters define how each respirator type is tested. Upon initial setup, a regulation was selected. This selection can be changed in the settings.

Select the mask type, and the appropriate parameters will be displayed.

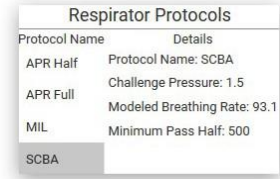

Protocol Name	Details
APR Half	Protocol Name: SCBA
APR Full	Challenge Pressure: 1.5
MIL	Modeled Breathing Rate: 93.1
SCBA	Minimum Pass Half: 500

If for some reason, a change is needed for a specific regulation (minimum passing fit factor, challenge pressure, etc.), An Administrator can create or duplicate an existing regulation, and make the required changes. This is highly discouraged as the regulations are in place as required. Regulations will be added or modified to the software when changes or updates become available.

When clicking on the Update icon, The software will give a notification stating whether there is a software update available or not. In the Setup section of the Setup options, there is an option to turn on or off the ability for the software to automatically update. With the auto update turned on, whenever there is a new release, the operator will be prompted to confirm that he or she wants the update to occur.

About

In the About section, information is included for:

OHD Contact Information

Address: 2687 John Hawkins Pkwy, Hoover, AL 35244, USA Phone: +1-205-980-0180

Website: www.ohdglobal.com

Email: sales@ohdglobal.com, techsupport@ohdglobal.com

Software version

Quick Links to useful websites

Reports

Report Settings

You can add your logo to your reports by clicking on Change Logo button and selecting your image file. If you click Reset Logo, it will revert to the default OHD logo. There are several types of reports that can be produced from OHD Logic.

- **Fit Test Report:** The report that would print at the end of a fit test which contains all the pertinent information to be recorded for an individual test.
- **Fit Test Summary:** A report including the summary for a selected company or a specific period of testing.
- **Fit Test Card:** This report will print to a card printer so that people may carry a record of their fit test.
- **Fit Test Log:** The Fit Test Log Report prints a snapshot of Fit Tests. The user can choose which columns appear on this report. This is confined by the space limitations of the width of the printed page.

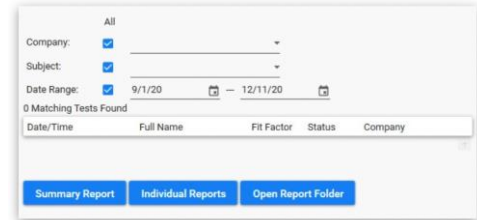

When a report is saved, it can be found as a PDF inside the Reports Folder. Click on the button to open the Reports Folder.

Database Functions

○ Data Import

The QuantiFit2 gives you the capability to import a database from another computer, import Portacount files, as well as import csv files from FitTrack Gold and Personnel & Test data lists. Follow the file structure for each import in the  section of the Settings-> Data -> Import section.

○ Data Export

You can export your entire database that can be imported to another computer. Choose Export button next to OHD Logic Database. It will prompt you to confirm the export. Then save your file (.ldb) to a USB drive. Then you will be able to import this file to another computer using the Import button.

You also have the option to export select areas of your database using the blue buttons next to Export CSVs

Troubleshooting

Graph Behavior:

The way the traceline of the graph displays during a test may be very helpful to understand a test step. Below you will find images with common traceline drawings.

Inhalation valve not removed or propped open

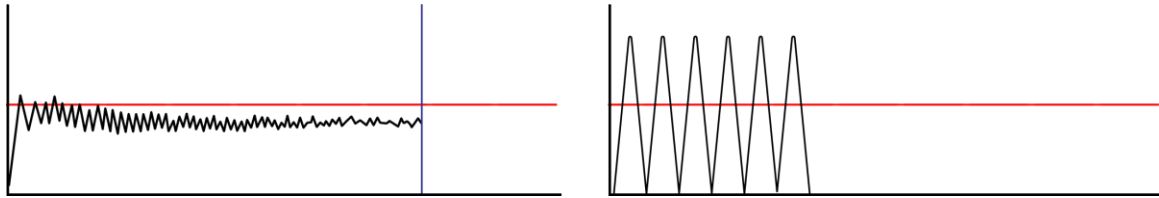

When the inhalation valve is interfering with the fit test, this is what the traceline will look like. On the adapter side with the two tubes attached, the airway needs a clear path into the respirator. If the way is not clear, the above graph will appear.

1. The inhalation valve can be propped open from the outside of the respirator before the adapter is connected.
2. Use an OHD valve prop to keep the valve intact and open during the fit test (pictured here).
3. If a valve prop is not available, other materials may be used. Take care not to damage the valve when inserting an object to prop it open.
4. For some respirators, it might be easier to remove the inhalation valves before the test, and then replace them at the end of the fit test.



HIGH LEAKAGE - Large leak is measured

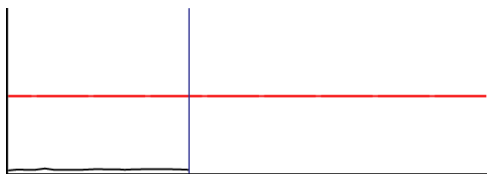

When the traceline does not lift above the bottom of the graph, this indicates that the QuantiFit2 has detected a large leak in the respirator. This would be related to a leak in the integrity of the respirator, a poor donning, or poor fit of the respirator.

1. Check all tubing connections for secure attachment and confirm there are no holes or tears.
2. Check to ensure that the QuantiFit2 respirator adapter is properly attached to the respirator. Look for cross-threading, loose connection, etc.
3. Check respirator for proper tightness to the face and check that no hair, beard stubble, unique face characteristics, or other objects inhibit a good face-to-facepiece seal.
4. Try a different respirator. Many respirators *seem* to fit well but are not properly sized to a specific wearer. In other cases, a different size or style may be better suited for the individual wearer.

Troubleshooting

Failure to reach challenge pressure

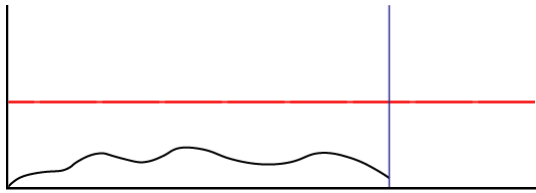

Like the large leak, when the traceline does not reach the challenge pressure line, this indicates that there is a moderate leak between the QuantiFit2 and the person wearing the respirator.

1. Check all tubing connections for secure attachment and confirm there are no holes or tears.
2. Check to ensure that the QuantiFit2 respirator adapter is properly attached to the respirator. Look for cross-threading, loose connection, etc.
3. Check respirator for proper tightness to the face and check that no hair, beard stubble, unique face characteristics, or other objects inhibit a good face-to-facepiece seal.
4. Try a different respirator. Many respirators *seem* to fit well but are not properly sized to a specific wearer. In other cases, a different size or style may be better suited for the individual wearer.

Perfect graph but still fails

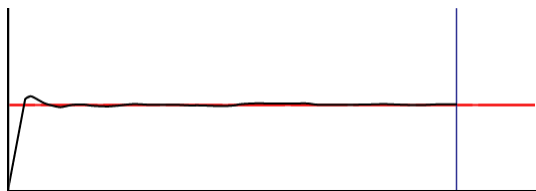

When the graph looks like a perfect fit test, but the fit factor is too low to pass, this means that there is a leak, but it's not a huge leak. This would be related to a leak in the integrity of the respirator, a poor donning, the fit of the respirator, a fault in an adapter, or a dirty exhalation valve in the respirator. Be sure to clean the exhalation valve with a moist wipe. As in other leakage situations (see HIGH LEAKAGE), check all tube connections, adapters, and adapter connections to respirators.

1. Check for proper tension of respirator to face.
2. Try a different size or different respirator.
3. Check fit test adapter for leaks. Check Troubleshooting section 3. Adapter Fault below. OHD provides this as an optional service during yearly calibration

Troubleshooting

Traceline way above challenge pressure line

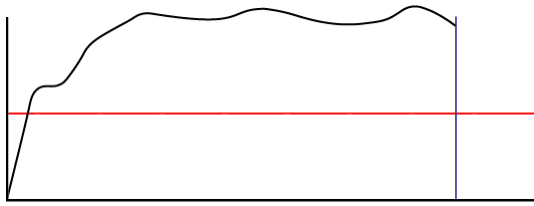

The QuantiFit2 traceline goes opposite of the direction of the pressure. If the line is above the challenge pressure line, that means that there is too much negative pressure. In this case, a test subject is most likely continuing to draw a breath in during the test. Movement by the person being tested needs to be minimized. Actions such as swallowing or opening the mouth, can adversely affect the pressure sensor and will be indicated by an erratic traceline.

1. Air inhalation or exhalation, even slightly, creates dramatic changes within the respirator. Instruct the test subject to maintain breath holding during the test measurement.
2. A test subject may be unable to stop the flow of air through the nose while holding his or her breath. A nose clip can assist the subject (be sure that the nose clip does not interfere with the fit of the respirator).
3. Improper breath hold. Instruct the user to relax, take a comfortable breath and hold as if going under water.

The pressure inside the respirator drops during the test

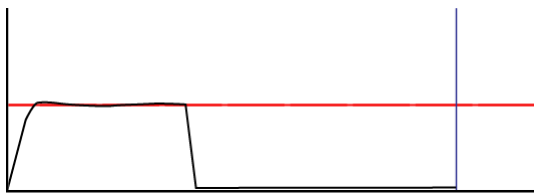

This graph would indicate that the challenge pressure was achieved, but during the test, a leak source opened. This could be the result of an exhalation valve that is in poor condition, or from the test subject moving his or her head, or subject stopped holding their breath and creating a leak in the seal.

1. Clean the exhalation valve in the respirator
2. Instruct subject to take a normal breath in, and hold as if going under water
3. Examine the condition of the respirator

Troubleshooting

Large up-and-down spike during the test

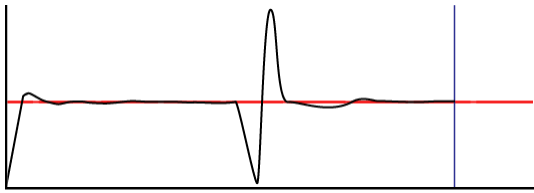

When the traceline goes way down and then way up, this would indicate that the test subject swallowed or stopped holding their breath during the test.

1. Instruct the test subject to remain calm and not to swallow or move during the test measurement.
2. Remove distractions from the area that may be interfering with the test (e.g., other test subjects making the test subject nervous or laugh during a test).

Failing Fit Factors:

Low Fit Factors

When fit factors are consistently low, the respirator may be a poor fit for that person. If the graph looks normal and the fit factor is low, that means that the QuantiFit2 is successful in meeting the challenge pressure, but a large volume of air is required to be removed to achieve that targeted pressure, which means the leak is too large.

When the leak rate is large, the graph can still look somewhat normal. The QuantiFit2 will often be able to keep up with the leak and give a good test result, although the leak is too large to yield a passing fit factor.

1. As in other leakage situations (see HIGH LEAKAGE), check all tube connections, adapters, and adapter connections to respirators.
2. Check for proper tension of respirator to face.
3. Be sure that the mask is centered on the head, and that the straps are pulled equally on both sides.
4. Try a different size or different respirator.
5. Check adapter for leaks Check Troubleshooting section 3. Adapter Fault below. OHD provides this as an optional service during yearly calibration.

Fit Factor of 0

When the fit factor equals 0, this indicates that the QuantiFit2 was not able to sustain the challenge pressure long enough, or that the traceline movement was so great that the QuantiFit2 did not receive accurate data to calculate a leak rate or fit factor.

1. Movement by the person being tested needs to be minimized. Actions such as swallowing, opening the mouth, and moving the tongue can adversely affect the pressure sensor.
2. Air inhalation or exhalation, even slightly, creates dramatic changes within the respirator. Instruct the test subject to maintain breath hold during the test measurement.
3. A test subject may be unable to stop the flow of air through the nose while holding his breath. A

Troubleshooting

nose clip can assist the subject (be sure that the nose clip does not interfere with the fit of the respirator).

4. Improper breath hold. Instruct the user to relax, take a comfortable breath and hold as if going under water.

Trouble Passing Fit Test

What do I do when people are not passing a fit test?

This problem could include several variables, but most likely would fall into three categories: instrument failure, respirator fit, or adapter fault. If it's a one-time problem when other people can pass, the answer simply may be that the respirator is not a good fit on the subject. When several subjects can't pass, look at the other variables:

1. Instrument Failure

- a. You must do the Daily Verification Check at the beginning of each day.
- b. If the QuantiFit2 passes the daily verification procedure, this assures that the instrument is operating properly and measuring within tolerance.
- c. If the QuantiFit2 is not able to complete the Daily Verification Check. Please contact OHD Tech Support to troubleshoot before sending in for service.

2. Respirator/Fit Fault

- a. The Operator must first determine that there is a proper fit. Any facial hair, hair getting anywhere under the respirator seal, temple hair too far forward, sunken temples or facial scarring, protrusions, or blemishes, having the respirator too loose or too tight, all can be reason enough to keep the QuantiFit2 from pulling a negative pressure within the respirator. There are other obstacles that can come into play which are too numerous to list. With more experience fit testing, it's easier for one to see potential problems with fit.
- b. To further check on the respirator fit, do a user seal check for 10 seconds. Press the Seal Check button located on the test screen and take in a breath and hold the pressure allowing for plenty of suction on the respirator. If after 10 seconds the respirator "drops" when releasing the Seal Check button, this indicates a good fit. If after the same procedure there is no drop or "falling away" from the face, this indicates that all the air leaked out through a leak source and is the reason for a failed test step.
- c. Exhalation valves may be dirty or creased allowing air to be pulled into the respirator. While the inhalation valves must be removed or propped open, the exhalation valve must remain in place and maintain a good seal. Clean the side of the valve that faces the interior of the respirator. This can be done with water and will remove any small obstruction that is keeping the valve from closing in an air-tight manner.
- d. On the respirator, the apex of the head straps should sit on the crown of the head and not off to one side or the other.
- e. Check the manufacturer's recommendation for properly donning a respirator and ensure that the user has been properly trained in donning that respirator as part of the regulations. All straps must be pulled with equal tension at each point.

Troubleshooting

3. Adapter Fault

- a. The adapters must be kept clean and in good shape.
- b. Disconnect and reconnect all tubes to make sure the connectors “snap” securely into place. Hold the assembly by the tubes rather than the metal connector.
- c. To verify the adapter is air-tight, connect only the blue tube to the adapter with the single tube connection. Submerge the adapter and tube connection completely under water. Then press and hold the SEAL CHECK button for at least 5 seconds. Repeat this several times. If bubbles like boiling water are seen coming from the adapter, there is a leak in the diaphragm or in the eight screws holding the top plate on. Replace the diaphragm and tighten screws firmly. Conduct the test again to ensure no bubbles are seen.
- d. Check all screws and connectors. If the screws on the top of the adapter are not tight, or if the tube connector ports can be turned by hand, this means they are not tight enough and may be introducing a leak into the system.

Daily Verification Errors

The Daily Verification normally functions to completion without any intervention from the Operator. However, occasional problems may arise. The calibration procedure may stop abruptly or display an error message.

Possible Problems:

- Something has blocked or partially obstructed the leak orifice on the Dual Tube Assembly and has rendered the tube out of tolerance.
- The transducer needs factory calibration.
- Check all tubing for holes or tears.

Possible Solution:

- Turn QuantiFit2 off, wait 15 seconds, power on, and retry Daily Verification.
- Remove and replace all tubes.
- Contact OHD Tech Support to evaluate problem or to arrange return to OHD Service Department.

Bluetooth Connection Issues

If you are having issues connecting via Bluetooth, make sure you are pairing from the Logic Software and not through Windows settings. Next check that in your Windows Bluetooth settings that the button is set to “On”

Troubleshooting

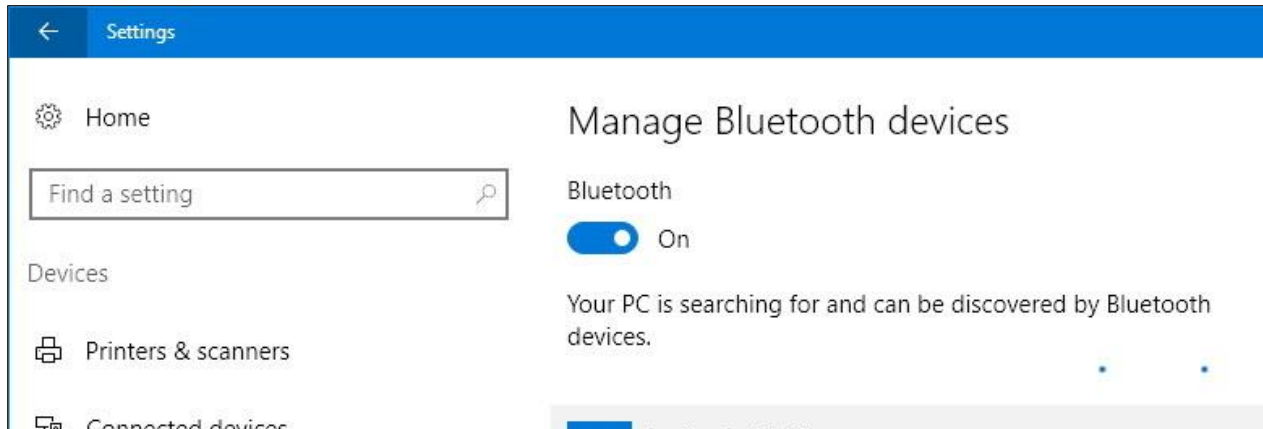

Make sure your device is turned on. Then turn off the QuantiFit2, wait a few seconds, then turn back on. Check to make sure it is not too close to any other USB devices. Sometimes unshielded USB devices can interfere with Bluetooth connections.

Should service be needed for your instrument, contact the OHD Service Department. For those instruments outside the U.S.A., contact OHD to find the nearest service center.

CAUTION: The QuantiFit2 is intended to be serviced only by authorized service personnel. Service procedures should only be performed by qualified technicians.



If the QuantiFit2 appears to be tampered with, this may render the warranty null and void. For service and operation questions, contact OHD: service@ohdglobal.com, +1.205.980.0180.

Calibration and Maintenance

To ensure that the QuantiFit2 is working properly and within specification, a daily verification must be performed before each day of testing, and an annual factory calibration must be done once each year.

Reasons for Annual Maintenance & Calibration:

The QuantiFit2 is a highly accurate precision instrument that uses electronic pressure sensors to detect minute changes to very low levels of negative pressure to an accuracy of +/- 0.25%. To ensure the instrument operates at the parameters for which it is designed, OHD requires the QuantiFit2 to receive annual maintenance and calibration at an authorized service facility.

- OSHA Mandate – 29 CFR 1910.134 Appendix A Part I.C.1.(b) – “The employer shall ensure that QNFT equipment is kept clean and is maintained and calibrated according to the manufacturer’s instructions so as to operate at the parameters for which it was designed.”
- Best Practice – Annual calibration and maintenance is the accepted industry standard for Industrial Hygiene and Occupational Health instrumentation.
- Reliable Results – The QuantiFit2 is a precision instrument that is used to help ensure employee safety. Critical decisions are made based on the results provided by the QuantiFit2. All precision instruments require some degree of calibration to ensure the measurements are accurate.
- Limits Liability – Complying with the manufacturer’s guidelines establishes good faith efforts towards employees’ health and safety. Failure to comply with established safety protocols could be viewed as negligent.
- Extends Service Life – The heart of the QuantiFit2 is a mechanical piston type pressure engine. Included in the calibration procedure are pressure engine checks. The pressure engine is completely disassembled, cleaned, and lubricated where warranted.
- Lifetime Powertrain Warranty – Receiving annual calibration extends the lifetime powertrain warranty on the QuantiFit2.
- Upgrades – The calibration process includes upgrades to the latest firmware versions and modifications as needed.
- Confidence – Our NIST (National Institute of Standards and Technology) traceable calibration assures that the unit is operating properly within accepted parameters.

Appendix A: Specifications

General

Input Voltage.....	12VDC, Center Positive, 3A Max
Power Supply.....	Universal, 100-240VAC, 50/60Hz 1A Max
Overvoltage Category	2
Operating Temperature (max based on configuration)	5 to 45°C
Humidity Range.....	20 to 80%, Non-Condensing
Setup Memory.....	20 GB
Size.....	(H) 11 x (W) 4.4 x (D) 15 inches
Weight.....	8.5 lbs

Dynamic Range

Leak Test Measurement.....	2-5000 cc/min
Resolution.....	0.1 cc/min
Fit Factor Computation.....	6-53,000
Resolution.....	1

Pressure Sensor - Fit Testing

Pressure Range.....	0-20 inches of water
Resolution.....	0.01 inches of water
Accuracy	± 0.25% FS

Pressure Sensor – Pump

Pressure Range.....	0-20 PSI
Resolution.....	0.1 PSI
Accuracy	± 2.5% FS

Instrument Accuracy

Challenge Pressure	± 5%
Leak Rate Measurement.....	± 3% or ±3 cc/min (whichever is greater)
Display.....	800 x 480 pixels
Touchscreen	Capacitive Touch

Environmental

Pollution Degree.....	2
-----------------------	---

USB Interface

4 Type A Ports (Keyboard, USB Memory, Printer).....	4
1 Type B Port (PC Communication).....	1

PC Requirements for OHD Logic Software

Operating System	Windows 10 or newer
Processor Speed	1.0 GHz or greater
RAM.....	1 GB or greater
Disc Space.....	16 GB

Certifications

- UL61010-1/CSA C22.2
- EN 61326-1:2013
- FCC Part 15 Subpart B
- Industry Canada ICES-003 Issue 6

Appendix B: Import Personnel Template

To import a list of names directly into the QuantiFit2, an Excel spreadsheet must be filled out with specific headers (see below). Fields can be empty and will be empty on the unit when imported. After populating the spreadsheet, save to a USB drive. Insert the USB drive into the back of the QuantiFit2 machine. On the Home screen, click on People/Test button. Then click the green down arrow button and the csv files will display from the USB Drive. Highlight the file and click the green checkmark button, then confirm you want to add users to the QuantiFit2.

	A	B	C	D	E	F	G	H
1	first name	middle	last name	id	company	note		
2								
3								
4								
5								
6								
7								
8								
9								
10								
11								
12								

Appendix C: Terminology

Air-purifying respirator (APR) a respirator with a filter, cartridge, or canister that removes specific air contaminants by passing ambient air through a purifying element.

Atmosphere-supplying respirator a respirator that supplies the user with breathing air from a source independent of the ambient atmosphere and includes supplied-air respirators (SARs) and self-contained breathing apparatus (SCBA) units.

Condensation Nuclei Counting (CNC) method of Quantitative fit testing (QNFT) also known as ambient aerosol which measures aerosol concentration inside the breathing zone of a respirator and outside of the respirator with the use of a probe. The aerosols measured inside the respirator are assumed to be the result of leakage.

Controlled Negative Pressure (CNP) method of Quantitative fit testing (QNFT) that pulls and maintains a negative pressure inside a respirator by removing, and directly measuring, any air that leaks into the facepiece.

Fit factor a numerical representation of the fit of a respirator to a specific individual; typically estimating the ratio of the concentration of a substance in ambient air to its concentration inside the respirator when worn.

Fit test the use of a protocol to qualitatively or quantitatively evaluate the fit of a respirator on an individual.

Powered air-purifying respirator (PAPR) an air-purifying respirator that uses a blower to force the ambient air through air-purifying elements to the respirator inlet covering.

Pressure demand respirator a positive pressure, atmosphere-supplying respirator that admits breathing air to the facepiece when the positive pressure is reduced inside the facepiece by inhalation.

Self-contained breathing apparatus (SCBA) an atmosphere-supplying respirator for which the breathing air source is designed to be carried by the user.

Supplied-air respirator (SAR) or airline respirator an atmosphere-supplying respirator for which the source of breathing air is not designed to be carried by the user.

User seal check an action conducted by the respirator user to determine if the respirator is properly seated to the face.

Appendix D: CNP Diagram

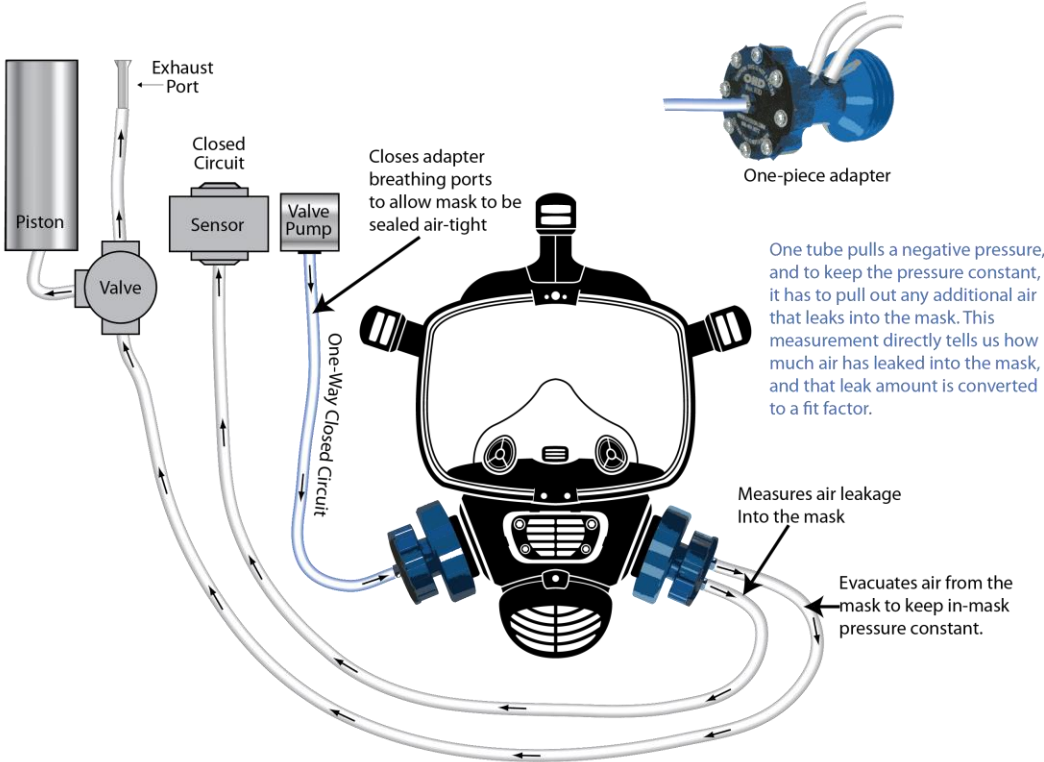

Appendix E: Regulations

Links to select regulations are shown below. Please ensure you are following all applicable standards, regulations, and guidelines.

OSHA (Occupational Safety and Health Administration)

[1910.134 - Respiratory Protection. | Occupational Safety and Health Administration \(osha.gov\)](#)



CSA (Canadian Standards Association)

[CAN/CSA-Z94.4-18 | Product | CSA Group](#)



UK-HSE (Health and Safety Executive)

[Guidance on respiratory protective equipment \(RPE\) fit testing - INDG479 \(hse.gov.uk\)](#)



ISO (International Standards Association)

[ISO - ISO 16975-3:2017 - Respiratory protective devices — Selection, use and maintenance — Part 3: Fit-testing procedures](#)



Appendix F: Fit Test Adapters

Fit test adapters are required to create an interface between the QuantiFit2 and the respirator. These adapters are inserted where the filters, cartridges, or regulators mount to the respirator. Each respirator manufacturer has its own unique cartridges, filters, or regulators to attach to their models. OHD matches the connections which will allow an interface.

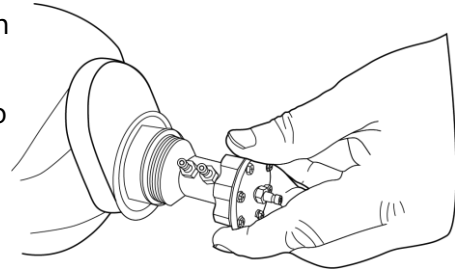

In the case of an SCBA, the respirator might be required to be converted to an air-purifying respirator.

OHD testing adapters must be maintained with care. Any dents or cracks that can occur will lose the ability to keep an air-tight seal, which would make it inadequate for testing.



Adapters can come in a one- piece or two-piece arrangement called "kits." The two-piece kit is for the bayonet connection, or connections on either side of the respirator. These are used mostly for air purifying respirators. The one-piece adapters take the place of a gas filter or SCBA connection and are typically used on those types of respirators.

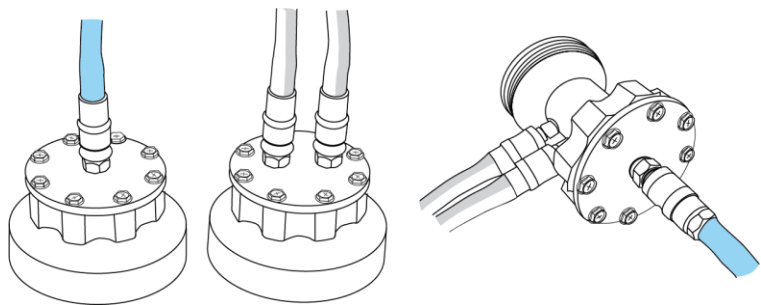

When attaching the hose assembly for testing, the blue tube always connects to the single port, and the gray and transparent hoses connect to the two ports side-by-side. For the gray and transparent tubes, it does not matter which connector gets which tube if the blue connects to the single port.

Adapters can be cleaned or disinfected in various ways. A disinfectant spray can be used, or the adapter may be submerged in a disinfectant liquid solution. The adapter must be completely dry before the next use.

To view the most updated [adapter list](#), visit the OHD website, www.ohdglobal.com.

To troubleshoot the fit test adapters, see [Adapter Fault](#) in the Troubleshooting section.